

# National Commission on the Structure of the Air Force



Report to the President and Congress of the United States  
JANUARY 30, 2014





**NATIONAL COMMISSION ON THE STRUCTURE OF THE AIR FORCE**  
SUITE 200, JAMES POLK BUILDING  
2521 SOUTH CLARK STREET  
ARLINGTON, VA 22202  
(703) 545-9113

January 30, 2014

**DENNIS MCCARTHY**  
CHAIR

President Barack Obama  
The White House  
1600 Pennsylvania Ave, NW  
Washington, DC 22002

**ERIN C. CONATON**  
VICE CHAIR

**LES BROWNLEE**

**JANINE DAVIDSON**

The Honorable Carl Levin  
Chairman, Committee  
on Armed Services  
United States Senate  
Washington, DC 20510

The Honorable James Inhofe  
Ranking Member, Committee  
on Armed Services  
United States Senate  
Washington, DC 20510

**MARGARET HARRELL**

**RAYMOND JOHNS**

**F. WHITTEN PETERS**

**BUD WYATT**

The Honorable Howard McKeon  
Chairman, Committee  
on Armed Services  
United States House of  
Representatives  
Washington, DC 20515

The Honorable Adam Smith  
Ranking Member, Committee  
on Armed Services  
United States House of  
Representatives  
Washington, DC 20515

Dear Mr. President, Chairmen and Ranking Members:

The National Commission on the Structure of the Air Force is pleased to submit its report of findings, conclusions, and recommendations for the legislative and administrative actions we believe will enable the Air Force to best fulfill current and anticipated mission requirements in the challenging years ahead.

In conducting the work that led to our report, the Commission held numerous open hearings in Washington and at Air Force installations and cities throughout the nation. We heard formal and informal testimony from Air Force leaders of many ranks; from the men and women serving in the ranks of all three components of the Air Force; from Governors, Senators, Representatives, and local officials; and from Air Force retirees and private citizens. We received and read hundreds of documents submitted for our consideration. This open and inclusive process gives us a high degree of confidence in our conclusions and recommendations.

Some of our recommendations represent fundamentally different approaches to the ways in which the Air Force has employed and managed its Total Force in the past. We recommend a greater reliance on the Air National Guard and Air Force Reserve; creating opportunities and incentives for longer service in uniform to minimize military personnel and family turmoil; and increasing opportunities for movement by Airmen within the components of the Air Force. These recommendations will lower overall military personnel costs, and they will produce a more ready and capable force by preserving funds for operations, maintenance, procurement, and recapitalization. The personnel-related actions we recommend make better use of the Air Force's deep reservoir of talent and will also have the effect of maintaining the readiness of the Air Reserve Component that would otherwise be diminished by disuse. Accordingly, we conclude that these recommendations should be followed even if budget constraints did not exist.

We also make recommendations in two areas that are addressed specifically because of the pressures imposed by declining budgets. Past Air Force efforts to reduce its overall inventory of equipment and installations have been driven primarily by the need to preserve capital for people and operations. We learned much about those pressures and the sometimes painful choices they require. We offer recommendations relating to aircraft inventory and to installations that we believe can mitigate the negative consequences associated with those choices.

We chose our cover photo with care. It reflects the fact that emerging mission areas such as the use of remotely piloted aircraft will become increasingly important in the future, and that such changes present both challenges and opportunities. The Airman's component is neither apparent nor important. In the Total Air Force we envision, the seamlessness of Airmen, their skills and expertise is critical.

We learned much about the role the Air Force can and should play in support of the nation's governors when they are faced with recovering from natural or man-made catastrophes. We recommend actions that both the Department of Defense and the Air Force should take to improve their ability to provide defense support to civil authorities.

A capable and highly professional staff supported the Commissioners throughout our work and we are deeply grateful to them. They were drawn from various DoD offices, from multiple Air Force components and commands, from other services, and from the civilian world. In short order, they came together under the able leadership of our Executive Director, Dr. James Blackwell. The work of the Commission could not have been accomplished without Jim and his team. We depart slightly from Air Force tradition to say "Bravo Zulu" to them all.

Finally and most importantly, the Commissioners respectfully acknowledge our ultimate "customers," the dedicated and spirited men and women of the U. S. Air Force and the families who support and enable their service. The Air Force of the future cannot look exactly like today's force, and any significant change is inherently disruptive. We believe that the changes we recommend will serve those "customers" well, and that the force we envision will provide better and fuller opportunities for the men and women of the Air Force to thrive in the service of their nation.

Respectfully submitted,

  
Dennis McCarthy, Chair


  
Erin C. Conaton, Vice Chair

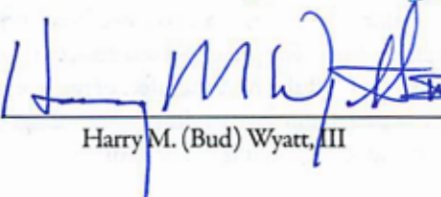
  
Les Brownlee

  
Janine Davidson

  
Margaret C. Harrell

  
Raymond E. Johns Jr.

  
F. Whitten Peters

  
Harry M. (Bud) Wyatt, III



# TABLE OF CONTENTS

REPORT TO THE PRESIDENT AND CONGRESS OF THE UNITED STATES . . . . . 1

TABLE OF CONTENTS . . . . . 3

THE COMMISSIONERS . . . . . 5

EXECUTIVE SUMMARY . . . . . 7

CHAPTER 1: INTRODUCTION . . . . . 13

CHAPTER 2: RESOURCES . . . . . 21

CHAPTER 3: REBALANCING THE COMPONENTS . . . . . 27

CHAPTER 4: SIZING AND SHAPING THE FORCE . . . . . 35

CHAPTER 5: MANAGING THE FORCE . . . . . 45

APPENDIX A: ESTABLISHMENT OF COMMISSION . . . . . 53

APPENDIX B: RECOMMENDATIONS. . . . . 56

APPENDIX C: RECOMMENDATIONS: RESPONSIBLE OFFICIAL . . . . . 60

APPENDIX D: ADDITIONAL VIEWS . . . . . 64

APPENDIX E: CLASSIFIED ANNEX CONTENTS . . . . . 68

APPENDIX F: COMMISSION ACTIVITIES . . . . . 69

APPENDIX G: TESTIMONY AND ORAL PUBLIC COMMENTS TO THE COMMISSION . . . . . 71

APPENDIX H: GLOSSARY OF TERMS AND ACRONYMS . . . . . 83

APPENDIX I: RESOURCE CHAPTER CHARTS . . . . . 91

APPENDIX J: SELECTED STATUTES AND POLICIES . . . . . 92

APPENDIX K: CORE FUNCTION BALANCE. . . . . 100

APPENDIX L: ADVANCED DECISION SUPPORT TOOL . . . . . 102

APPENDIX M: NCSAF WAR GAME . . . . . 107

APPENDIX N: AUTHORITIES . . . . . 112

APPENDIX O: DISTINCTIONS AMONG HOMELAND OPERATIONS . . . . . 114

APPENDIX P: COMMISSIONER BIOGRAPHIES . . . . . 116

APPENDIX Q: COMMISSION STAFF . . . . . 121

APPENDIX R: SOURCES CONSULTED . . . . . 122





# NATIONAL COMMISSION ON THE STRUCTURE OF THE AIR FORCE



**THE HONORABLE DENNIS M. MCCARTHY,  
CHAIR**

Principal, Military Experts LLC  
Assistant Secretary of Defense for Reserve Affairs,  
2009-2011  
Executive Director of the Reserve Officers  
Association, 2005-2009  
Lieutenant General, USMC (Ret)



**THE HONORABLE ERIN C. CONATON,  
VICE CHAIR**

Under Secretary of Defense for Personnel and  
Readiness, 2012  
Under Secretary of the Air Force, 2010-2012  
Staff Director of the House Armed Services  
Committee, 2001-2005  
Research Staff Director for the U.S. Commission on  
National Security/21st Century, also known as the  
Hart-Rudman Commission, 1998-2001



**THE HONORABLE F. WHITTEN PETERS**

Partner, Williams & Connolly LLP  
Secretary of the Air Force, 1999-2001, and Under  
Secretary and Acting Secretary of the Air Force,  
1997-1999  
Principal Deputy General Counsel at the  
Department of Defense, 1995 - 1997  
U.S. Navy Reserve officer, 1969-1972



**THE HONORABLE R.L. (LES) BROWNLEE**

Acting Secretary of the Army, 2003-2004  
Under Secretary of the Army, 2001-2004  
Staff Director of the Senate Armed Services  
Committee, 1996-2001  
Retired Army colonel who served two tours in  
Vietnam, earning a Silver Star with oak leaf cluster,  
a Bronze Star with two oak leaf clusters, and a  
Purple Heart.



**GENERAL (RET) RAYMOND E. JOHNS JR.**

Senior Vice President, Flight Safety International  
Commander, Air Mobility Command, 2009-2013  
Deputy Chief of Staff for Strategic Plans and Policy,  
U.S. Air Force, 2006-2009  
White House Fellow, Office of National Service and  
National Security Council, 1991-1992  
Retired Air Force General, a 1977 Air Force Academy  
graduate flying C-17, C-141, KC-10, and N/K/C-135V,  
and was chief test pilot and test program manager  
for the VC-25 Air Force One.



**LIEUTENANT GENERAL (RET) HARRY M. "BUD"  
WYATT III**

Director, Air National Guard, 2009-2013  
Oklahoma Adjutant General, 2003-2009  
Associate District Judge for the State of Oklahoma,  
1998-2003  
Retired Lieutenant General, entering the Air Force  
in 1971 and as a command pilot logged more than  
3,000 hours in the A-7, C-26, F-16, F-100, F-106, T-33,  
T-37 and T-38 aircraft



**DR. JANINE DAVIDSON**

Senior Fellow at the Council on Foreign Relations  
Deputy Assistant Secretary of Defense for Plans,  
2009-2012  
Director in the Office of the Assistant Secretary of  
Defense for Special Operations and Low Intensity  
Conflict, 2006-2008  
Air Force pilot who flew C-130 and C-17 in combat  
support and humanitarian air mobility missions  
in Asia, Europe, and the Middle East and was an  
instructor pilot at the U.S. Air Force Academy



**DR. MARGARET C. HARRELL**

Director of the Army Health Program and senior  
social scientist at RAND Corporation, for whom  
she's worked more than 20 years  
Senior Fellow and Director of the Military Veterans  
and Society Program at the Center for a New  
American Security, 2011-12  
Author of several books on women in the military and  
Rand Publications on Guard and Reserve families  
Ph.D. in cultural anthropology from the University  
of Virginia

*For additional detail refer to:*

Appendix P: Full biographies of the members

Appendix Q: Commission staff and Executive Director  
biography.







# EXECUTIVE SUMMARY

The Air Force faces many challenges in meeting its national security mission within the resources currently envisioned. Doing so will not be easy or without risk, nor will it permit the application of traditional methods of allocating missions, equipment, and resources among the Air Force’s three components. After conducting 19 days of hearings involving 154 witnesses and oral public comments, and listening to currently serving Airmen of almost all ranks from the three components at 13 installations throughout the country, the Commission is convinced that the Air Force must change the way it organizes, aligns, and employs the great Americans who choose to serve in its ranks.

Congress directed the Commission to “...undertake a comprehensive study of the structure of the Air Force

to determine whether, and how, the structure should be modified to best fulfill current and anticipated mission requirements for the Air Force in a manner consistent with available resources.” The statute that created this Commission also specified that it address six considerations in its report to Congress and the President. The Commission fulfilled this mission in the time allotted.

Based on the record before it, the Commission arrived at a set of foundational conclusions that became its analytical starting point. Elements of that foundation are as follows.

- Past and current Air Force leaders have committed the resources and effort needed to allow the Reserve Components (RC) to maintain the same standards of skill and operational readiness as the Active Component (AC).
- “Part-time” force structure—that capability delivered by traditional Reservists and Guardsmen who do not serve continuously on active duty—costs less than the force structure provided by “full-time” personnel.
- Recognizing that some missions must be performed by the Active Component, the Air Force can, and should, entrust as many missions as possible to its Reserve Component forces.
- Transitioning missions from the Active Component to the Reserve Components will allow the Air Force to perform these missions with less expensive part-time Reservists while reducing the



Active Component end strength, thus saving money in the military personnel accounts that can be put to use in readiness, modernization, and recapitalization accounts. In this way, all components of the force will remain more ready and mission capable, and the Air Force will retain the capacity to surge its forces when needed.

- There is an irreducible minimum below which the Air Force cannot prudently cut Active Component end strength without jeopardizing war-fighting capability, institutional health, and the ability to generate future forces.
- Although Reserve Component force structure, especially traditional Reservists, costs less

than that of the Active Component, conducting operations with Reserve Component forces is not always less expensive than doing so with Active Component forces.

The Commission determined the following principles of force structure and force management that will allow the Air Force to meet present and future mission requirements within the limit of resources the Commission believes will be available.

#### Principles of Force Structure

- Both the Active and Reserve Components provide unique value to the Nation. The Total Air Force cannot succeed without three strong components. Prudent reductions in the Active Component will produce

meaningful cost-savings, mainly in the military personnel accounts, and can reduce the need for cuts to readiness, modernization, and recapitalization.

- The Air Force can maintain operational capacity and capability and reduce stress on the Active Component by maintaining or increasing the end strength of the Reserve Components, particularly in traditional part-time Reservists and Guardsmen, while increasing regular, periodic, and predictable use of the Air Force Reserve and the Air National Guard.
- Greater reliance on a larger Air Reserve Component provides a quick, *reversible* way to generate manpower cost savings (see Chapter 4). It provides an ability to surge, when needed, and additional return on investment in the high-cost, high-value training of Active Component Airmen. Shifting more capability to the Reserve Components also maintains a link to communities and states throughout the nation in our unique form of federalism.
- In order to gain maximum benefit from the Reserve Components, the Air Force must program sufficient operational support funding to permit utilization of individuals and units through volunteerism or under the authority of 10 U.S.C. §12304b.
- Increasing integration of Reserve, Guard, and Active Component Airmen at headquarters and units, and increasing the number of integrated or multi-component (“associate”) units will lead directly to improved processes as well as more effective and efficient employment of the Total Air Force. Further integration of the Air National Guard and the Active Component (as described in



Chapter 3) is a desirable goal but will require modifications to Titles 10 and 32 of the U.S. Code before the full value of such integration can be achieved.

### Principles of Force Management

- Removal of numerous barriers to a “Continuum of Service,” in which Airmen have greater flexibility to leave and re-enter Active and Reserve Components throughout their careers, will enable more effective and efficient utilization of an integrated Total Force. Some of those barriers are contained in law, but others reside solely in service policy, tradition, and culture.
- In addition to removing barriers to transitioning between components, Congress and the Department of Defense should modify laws and regulations that unnecessarily limit or restrict the length of service by qualified Airmen in certain career fields with high training costs. Doing so will allow the Air Force to more fully capitalize on the cost of training those Airmen.

### Specific Considerations

This summary will briefly address each of the specific considerations set forth by Congress. Congress directed the Commission to conduct a study that covers six specific considerations in evaluating the structure of the Air Force.

In the report that follows, future force structure and force management issues will be addressed and actionable recommendations proposed. The Commission believes that increasing force integration and fully tapping the individual and organizational potential of all Airmen is not optional. Accordingly, the Commission has made specific recommendations for Presidential, Congressional, Department of Defense, and Air Force action to move these issues into a “must do” category.

### A. Current and Anticipated Requirements of Combatant Commanders

The Commission formulated its force structure recommendations in relation to the forces called for in existing war plans and to what the Commission has learned are the daily demands for Air Force capability. Those day-to-day demands come from both the Combatant Commanders and from the Air Force’s own institutional requirements. The Commission concluded that the Air Force can field sufficient capability and capacity to meet both daily needs and surge-level requirements only if it effectively utilizes the full capacity of its Active and Reserve Components.

One specific conclusion in this area drove the Commission’s force structure recommendations: There are finite limits to the amount of air, space, and cyber power that the country can afford and that our Airmen can provide. The Commission found that the current force management system, in which Combatant Commanders generate day-to-day requirements, has proven so unconstrained as to be unsupportable. Accordingly, Combatant Commanders must be required to consider the budget and personnel impacts of their day-to-day planning to stay within the reasonable limits of manpower and budget authority that is available. In short, they must differentiate between needs and wants.

### B. Achieve an Appropriate Balance Between the Active and Reserve Components

In hearings and visits to Air Force installations around the country, the Commission learned about the strengths and capabilities resident in all components of the Air Force. Past policies of the Air Force have ensured that all units and individuals of the Active Air Force, the Air National Guard, and the Air Force Reserve train



to the same level of excellence and are thus equally ready to *fight tonight*.

Every Reserve Component Airman that Commissioners spoke to—ranging from the most senior to the most junior—told of untapped potential in both Reserve Components. These Airmen asserted that over the past decades those components had provided what they were asked to provide rather than the full limit of what they could provide. Commissioners tested these statements every way possible, recognizing that such high self-confidence cannot always be accepted at face value. But these assertions were so unanimous and came from so many disparate sources that the Commission cannot discount them.

The Commission also heard that, to take full advantage of untapped potential in the Reserve Components, the Air Force must change the way it employs the Air National Guard and the Air Force Reserve. These components are complementary to the Active Component, not precise mirror images. The Air Force must sometimes employ and manage the Reserve Components in ways that are distinct from how the Active Component is employed; and commanders will require greater knowledge about these distinctions. Accomplishing these goals will require integrating headquarters, eliminating redundant command chains and staffs, increasing opportunity for service in various



components throughout an Airman's career, increasing unit associations, and reducing administrative barriers between components.

### C. Ensure Sufficient Capacity for Homeland Defense and Disaster Assistance

The Air Force, particularly the Reserve Components, plays a significant role in both homeland defense and support of civil authorities. It can, and should, continue to do so; and, given the strategic environment and enhanced coordination with the Department of Homeland Security, the Air Force will have opportunities in the future to increase its contribution to these missions. Communication between state leaders and the Department of Defense can, and must, improve, particularly in the area of disaster assistance.

Although the Air Force should make no force structure decisions exclusively based on disaster assistance requirements, the use of the armed forces to address emergencies at home is a core mission of all military branches, including the Air Force. While the Commission does not propose the addition of force structure specifically for those missions, it

recommends treating Homeland Defense and Defense Support to Civil Authorities as real priorities, and Governors as essential stakeholders in planning processes. Doing so will enhance the Air Force's ability to contribute to the country's well-being without sacrificing the ability to deliver the air power needed and expected in the "away game."

### D. Ensure the Regular Air Force Can Provide a Base of Trained Personnel for the Reserve Components

It is essential to maintain a strong Active Component that, among other contributions, provides a base of trained personnel who can either transfer to the Reserve Components when their active duty service is completed or serve for a period in a Reserve Component before returning to active duty. Thus, there is a limit to how small the Active Component can be. Additionally, the cost-effectiveness of the Reserve Components depends on an optimally sized Active Component. While no element of Air Force capability should reside exclusively in any one component, the Active Component generally is expected to perform certain

core functions, such as procurement and RDT&E (research, development, test, and evaluation), that support all components of the Air Force. Given current capabilities, the Active Component force structure should comprise no less than approximately 55 percent of the Total Air Force end strength. While individual percentages will vary by mission and platform, a Total Force mix should be spread across every Air Force core function and Air Force Specialty Code (AFSC).

### E. Maintain Sufficient Force Structure to Meet Operational Tempo Goals of 1:2 for the Active Component and 1:5 for the Reserve Component

The deploy-to-dwell ratios specified in this Congressional consideration are less useful to the Air Force, which deploys in units smaller than wings or squadrons down to small groups of individual Airmen compared to land and naval forces that tend to deploy as regularly organized units (such as companies and ships). Because of the mismatch between the unit concept embedded in these ratios and Air Force deployment practices, different Air Force commands have chosen different methods for computing these ratios. Thus, the Air Force inconsistently applies these ratios across the force. As a result, attempts to use these ratios provide inconsistent and sometimes misleading information about the use rate of the Air Force's components and individuals.

The Air Force should utilize a single metric for measuring the personnel tempo and stress on its forces, both Active and Reserve. The Commission also recommends that the Air Force utilize this "PERSTEMPO, stress on the force" metric (described in Chapter 5 of this report) to determine goals for sustainable levels of employment for both the Active and Reserve Components and for specific elements of its force structure.



Such an approach will provide a more holistic picture of the actual stress on, or under-utilization of, Airmen and allow the Air Force to employ the Total Force more efficiently.

#### **F. Balance Affordability, Efficiency, Effectiveness, Capability, and Readiness**

Over the past several years, many missions have shifted toward the Reserve Components. The Commission proposes additional shifts to the Reserve Components in certain missions, particularly focusing on mission areas where the Air Force can effectively utilize a part-time force that deploys on a rotational basis. A force structure more reliant on a larger proportion of the Reserve Components will not look exactly like the force the Air Force has successfully employed in recent decades. Changing that force is not a criticism of the preceding force structure; it is recognition that the current and future budgetary and security environments present challenges that require new solutions. Sacrificing readiness to preserve force structure would create a hollow force. Instead, the Air Force can preserve readiness by shifting force structure missions from the Active to the Reserve Components.

If, as expected, the Air Force proposes to divest entire fleets, such as the A-10 and KC-10 aircraft, such retirements would likely project substantial cost savings. However, the units that operate those aircraft reflect decades of investments in those men and women who fly and maintain them, as well as in the facilities that the Air Force likely will need for emerging missions and new ways of using the Total Force. Because any such divestitures would be subject to Congressional approval, the Commission recommends that the Air Force develop and provide Congress a

detailed, complete, and comprehensive plan explaining how the Air Force will achieve missions undertaken by such platforms in the future and how it will retain the highly trained personnel from these fleets.

Shifting to a Total Force more reliant on Reserve Component part-time forces, combined with potential divestiture of complete aircraft fleets, will have significant implications for installations. Moreover, increasing the number of associate units could allow consolidation of support infrastructure, which would create added efficiencies. Air Force leaders repeatedly have pointed out that the Service already has significant excess of infrastructure. The trends described in this report likely will exacerbate that condition. The Commission recommends that the Congressional defense committees and the Air Force should consider, and the Congress should allow, the closing or “warm basing” of some installations. Attempting to operate all current bases at the same level of effort will require the Air Force to reallocate present and future funding and reduce some of the benefits that would otherwise be gained by the Commission’s force structure recommendations.

Many of the Commission’s recommendations have been considered before. Now, however, a new defense strategy focuses more on high-end warfare and fighting in denied environments while mission areas such as cyber, space, intelligence, surveillance, and reconnaissance (including the use of remotely piloted aircraft for these and other missions) continue to grow. With these trends and the need for fiscal discipline, the Commission believes that the Air Force can take additional risk by replacing some legacy capabilities with upgrades and new force structure investments that will increase the capability and

lethality of the force that remains.

Other solutions to emerging challenges involve employing the Air National Guard and Air Force Reserve in some mission areas to a greater extent than previously thought possible. The last few decades have shown the nation and the Air Force what its Reserve Components can do when they are employed skillfully. Despite decades of combat deployments, the Reserve Components have additional capacity to serve the nation’s needs. The Air Force should integrate the components more completely, giving Reserve Component Airmen more opportunities to serve, reducing both statutory and regulatory barriers among the components, and more broadly inculcating and institutionalizing an awareness of the value of the Total Force throughout the Air Force. A true “Continuum of Service” approach should be available to all Airmen. These actions will enable the reduction of military personnel costs while maintaining realistic levels of operational capability or readiness.

Although many have discussed increased integration of the components for several years, today’s Air Force is ideally positioned to make further advances in this area. In testimony before the Commission, Air Force leaders have demonstrated a forward-thinking approach to greater operational integration. This increased confidence reflects their professional experience in an increasingly integrated Total Force that has, over the past two decades, proven it can deliver during peace and war. The Air Force has been a pioneer among the Armed Services in integrating its components and in operating as a Total Force. Now is the time to institutionalize these best practices across the Air Force and to capitalize on them. ▶



“In the last 10 years we have gotten closer to the Total Force than ever because we shed blood together; so let’s not undo that. How we do it is as important as what we do. PB 13 was the first whiff of grapeshot; let’s get past that.”

*General Charles H. Jacoby Jr., Commander United States Northern Command and North American Aerospace Defense Command, in testimony before the National Commission on the Structure of the Air Force, Sept. 26, 2013.*

## CHAPTER 1

# INTRODUCTION

Congress created the National Commission on the Structure of the Air Force to conduct a “comprehensive study of the structure of the Air Force” and to make recommendations the Commission considered necessary. Congress also laid out six specific factors for the Commission to consider.

Given the relatively short time available, the Commission concluded that proposing a specific allocation of forces in each of the Air Force’s 13 “core functions” or attempting a detailed laydown of the number and location of each weapons system within the Air Force would be impractical, though this report does present sample approaches to illustrate the Commission’s findings and recommendations. Rather, the Commission focused on principles

that, if applied, would enable the Air Force to shape the details of its force structure to meet the national security challenges ahead.

The Commission therefore adopted for itself the following implied mission: *The Commission will address the considerations established by Congress*

*and recommend principles of force structure and force management that will allow the Air Force to meet present and future mission requirements within the limit of resources reasonably expected to be available.*

The Commission conducted its work with several basic tenets in mind.

## DEFINITIONS (as used in this report)

### FORCE STRUCTURE

The military service’s interconnected framework—Active, Reserve and Guard components, equipment, personnel, and real estate—that exists to accomplish specific missions in support of the President and the Secretary of Defense.

### TOTAL FORCE

All U.S. Air Force organizations, units, and individuals—Active, Reserve, Guard, and civilian—that provide the capabilities to support the Department of Defense in implementing the national security strategy.



Those were to be open and receptive to as wide a range of input as possible; to meet with and consider the opinions of the men and women currently serving in the Air Force; and to visit Air Force installations around the country. The Commission held 19 days of public hearings, heard from 154 individual witnesses, received written comments from 256 individuals, received and reviewed thousands of pages of documents submitted for our consideration, and, when necessary, met in closed sessions to consider classified material. A classified annex supplement to this report is available, however the Commission offered no classified recommendations. Witnesses ranged from the Secretary and the Chief of Staff of the Air Force to the most junior of Airmen. Commissioners heard from officers of almost every grade, from senior enlisted leaders, from federal and state elected officials, from retired service members, from business leaders, and from concerned citizens, all with a vital interest in their Air Force.

The Commission devised and conducted a seminar war game that enabled Commissioners to examine



broadly divergent mixtures of force structure in light of existing war plans and defense planning scenarios. The alternative structures the Commission studied in this way were not intended to represent a “right answer” or alternatives to one another. Rather, they were nominal structures that Commissioners found useful in illuminating selected issues from

radically different perspectives. The Commission was supported in this effort by the Center for Strategic and Budgetary Assessments and benefited from a review of its methodology by a representative from DoD’s Office of Net Assessment. Although constrained by the available time, Commissioners gained insight into both fiscal impact and potential unintended consequences



## DEFINITIONS

### **ACTIVE COMPONENT (AC)**

The unrestricted, continuously available personnel, units, and equipment of the Air Force. Section 8075 of Title 10 of the U.S. Code calls this component the Regular Air Force, but generally the services use the term *Active*.

### **AIR RESERVE COMPONENT (ARC)**

The forces of the Air National Guard and Air Force Reserve.

### **“FULL-TIME” FORCES**

A member of the Active Component, an Active Guard and Reserve member, or a Dual Status Military Technician. (See also “Part-Time” Forces.)

### **“PART-TIME” FORCES**

Forces comprised primarily of traditional Reservists or drill status Guardsmen. The Commission recognizes that most, if not all, traditional Guardsmen and Reservists in the Air Force dedicate themselves fully to their service’s core principles and ideals. This report uses this term only to differentiate the pay status of those not on full-time active duty.

### **SURGE**

A rapid or concerted increase in the commitment of forces to fend off an attack, meet a sudden demand, or accomplish a strategic military objective.

of various adjustments to force mix.

The war game was designed as a table-top seminar for Commissioners, supported by staff analysts, to develop insight into the issues involved in the strategic choices for the structure of the Air Force. This was not aimed at the usual objectives of war games, such as campaign outcomes, institutional transformation, portfolio rebalancing, capabilities assessment, or war-fighting concepts. One part of the game was a planning exercise in which three staff teams each developed a resource-constrained future Air Force structure given a particular assigned Active/Reserve mix as an analytic starting point. This event drew from authoritative current forecasts to provide constraining assumptions to the teams on future resources, fiscal guidance, force sizing, basing, and end strength. In the second event, the staff teams were required to play the role of the Air Force as force provider, employing the force structure they had developed in the planning exercise, during several phases of a hypothetical future crisis and conflict. This event adapted the scenario used in the Chairman of the Joint Chiefs of Staff Strategic Seminars. Throughout the exercise, Commissioners considered alternative force structures from the perspective of the Air Force as well as that of the Combatant Commanders, Department of Defense Senior Leaders, and Governors confronting the challenge of allocating force structure assets to competing demands from multiple near-simultaneous crises and conflict. Commissioners found this exercise helpful in sharpening their focus on the key issues, applying credible analytic tools, and exploring the range of the art of the feasible in considering force structure options.

The Commission reached several broad conclusions that formed the basis for its detailed findings and

## COMMENT

I became a part of Total Force Integration in May 2007 when the 192nd Fighter Wing of the Virginia Air National Guard was integrated with the First Fighter Wing at Langley Air Force Base. At that time I was serving as the E-7 Chief Host Aviation Resource Manager. Before our move to Langley, we felt confident in our abilities. It did not take long before our Guardsmen were considered experts and often viewed as the “go-to” people. Citizen Airmen bring unique and invaluable skill sets that are shared with our Active Duty counterparts.

Guardsmen have consistently been great trainers who present significant knowledge bases for their Active Duty counterparts. Since Guardsmen do not PCS, they seem to be the new stability, “holding down the fort” as well as participating in deployments and other wartime efforts.

*MSgt (Ret) Mary I. Meyer, Virginia Air National Guard*

recommendations. Some of those foundational conclusions might seem self-evident to some, but the Commission did not start with any preconceived notions. The following foundational conclusions, which might also be called “assumptions,” became ingrained in the Commission’s analysis gradually over the course of its work:

- Past and present Air Force leaders have committed the resources and effort needed to allow the Reserve Components to maintain the same standards of skill and operational readiness as the Active Component.
- The Air Force successfully has built capacity in its Reserve Components over time by adhering to, and funding, a single standard of operational readiness throughout all components. In other words, the Air National Guard and the Air Force Reserve are held to the same standards of operational readiness as is the Active Component.
- Part-time force structure—that capability delivered by traditional Reservists and Guardsmen who do not serve continuously on active duty—costs less than the force structure provided by full-time personnel.
- The Air Force can, and should,

entrust as many missions as possible to its part-time force.

- Transitioning missions from the Active Component to the Reserve Components would allow the Air Force to perform these missions with less expensive part-time Reservists while reducing the end strength of its Active Component, saving money in the military personnel accounts that it can put to use in readiness, modernization, and recapitalization accounts. In this way, all components of the force will remain more ready and mission capable, and the Air Force will retain the capacity to surge its forces when needed.
- There is an irreducible minimum below which the Air Force cannot prudently cut Active Duty end strength without jeopardizing war-fighting capability, institutional health, and the ability to generate future forces.
- While Reserve Component force structure costs less than that of the Active Component, conducting operations with Reserve Component forces is not always less expensive than doing so with Active Component forces.

These foundational conclusions will

receive amplification in other parts of this report.

### The Strategic Environment

Although the future security environment is unpredictable, the Commission assumes it will remain

at least as complex and dangerous as it is today. The United States must prepare for an array of overlapping challenges from state and non-state actors, including transnational criminals, terrorists, and other violent actors. As emerging powers refine

their capabilities and leverage new technologies, the permissive air and space environment the Air Force has enjoyed during the wars in Iraq and Afghanistan may not persist.

The Air Force also must be prepared to respond in the context of other destabilizing global trends, such as urbanization, demographic shifts, competition for resources, insecurity in cyberspace and outer space, and natural disasters. Because adversaries have learned to engage us asymmetrically to avoid challenging us conventionally, the Air Force must be prepared to deal with enemies armed with weapons of mass destruction and those who will leverage anti-access, area-denial capabilities that increasingly challenge the nation's traditional power projection strategies. Further, the Air Force must adapt to operate alongside traditional and new allies who may possess varying levels of military capability.

Meanwhile, the Commission assumes that even after the redeployment of most combat forces from Afghanistan, the steady-state demand on the Air Force—particularly air mobility capabilities, cyber forces, and intelligence, surveillance, and reconnaissance (ISR) assets—will continue to be high. Unforeseen crises and natural disasters, as well as regular military engagement and partnership missions called for in the President's strategy, will drive this demand. Although the Air Force will see periods of crises and "surge," there will exist no bright-line distinction between peace and war. The high demand for airpower will be continuous. The Air Force must retain the ability to surge high-end war-fighting capabilities with little or no advance notice while also sustaining capabilities across the spectrum, from humanitarian assistance and peace-keeping operations to its part in the nation's nuclear deterrence and assurance mission. Additionally,

## AWACS COMMANDER

Lt Col Keven "Hitch" Coyle, Commander of the 960th Airborne Air Control Squadron at Tinker AFB, Okla., recently returned from his 12th deployment to Southwest Asia. He has deployed in five different weapon systems and three different mission sets: Airborne Warning and Control System (AWACS), the



Control and Reporting Center (CRC), and Special Operations. He has been serving on active duty for 14 years and has worked and deployed with Guard and Reserve colleagues.

Lt Col Coyle has seen both sides of the 1:2 deployment target. AWACS is a high-demand, low-density asset. In order to meet the needs of the Combatant Commander (CCDR), his squadron's current deploy-to-dwell is 1:1 with his crews serving 180-day deployments. He is fully aware that the CCDR's needs drive the mission, but, as a squadron commander, he must balance that need with the needs of his people. He believes shorter deployment durations would provide a more balanced approach in meeting both needs. A 120-day deployment with a 1:2 deploy-to-dwell rotation would still satisfy CCMD mission requirements while enabling him to expand the pool of qualified aviators to deploy. This would keep his force fresh and build the unit's experience, too.

While deployed, his crewmembers flew approximately three times per week, but operations officer duties kept Lt Col Coyle on the ground more than he would like. "Flying often when deployed is a good thing," he said. "Time flies when you are busy. It is during the down times when you really miss your family and deployments seem to drag on." His 275 enlisted members and officers continually impress him with their willingness to sacrifice for the good of the nation. This dedication does not come without a cost, and Lt Col Coyle admits his family—a wife of 16 years and three children—bears the greatest cost of his service. He has missed many birthdays, baptisms, anniversaries, and holidays due to deployments.

"Team Tinker" includes units in all three Air Force components, and Lt Col Coyle sees cultural differences between the two Reserve Components and the Active Component resulting from operational tempo and laws. When working beside their Reserve and Guard colleagues, Active Component members see firsthand an opportunity to serve that offers relief from their deployment schedule and frequent moves. Lt Col Coyle said he has met many individuals who did not excel during their active duty time yet had fantastic Reserve careers. Conversely, he has met traditional Reservists who returned to active duty and continued to excel. The Active, Guard, and Reserve "complement each other very well," he said.



man-made and naturally occurring threats to Americans' well-being at home will demand that the Air Force provide traditional air defense as well as contribute military support to both the nation's Governors and non-DoD federal agencies.

The Air Force's structure must be adaptable to this broad range of missions and unforeseen challenges. Given these strategic realities, the Air Force cannot organize force structure along traditional AC-RC lines. The Reserve Components cannot be a traditional strategic reserve. Accordingly, Air Force men and women must be capable of meeting shifting, diverse demands in near real time. Doing so will require a scalable blend of full-time and part-time Airmen who all maintain appropriately high degrees of readiness. The nation will require these changes in force management irrespective of budget limitations.

### **The Force Structure Puzzle**

Pentagon force managers repeatedly testified to the Commission about the difficulty they have in meeting day-to-day Combatant Commander (CCDR) "demand" for air power within the given supply. This phenomenon also is reflected in the Air Force's struggle to meet the 1:2 deploy-to-dwell requirement in the Active Component. Yet, force planners from the Office of the Secretary of Defense, the Joint Staff, and the Air Force consistently testified to the Commission that, by their calculations, there exists excess capacity in the Air Force. This apparent gap between planned requirements and actual day-to-day "demand" seems to stem from a discontinuity between force planning and force management processes and expectations.

In the Pentagon's force-planning process, force structure is designed based on predicted surge requirements for large-scale warfare scenarios, which



can be envisioned up to 20 years in the future. This process is meant to ensure that the services are structured to meet the most stressful future war-fighting cases. Day-to-day operations, however, generate independent demands for capabilities such as Intelligence, Surveillance, and Reconnaissance (ISR), airlift, and partner engagement, as do unforeseen crises from each Combatant Commander that are simultaneous, nearly continuous, and unrelated to the scenarios on which the force structure originally was planned. These unconstrained CCDR demands often exceed available capabilities. The

day-to-day stress is exacerbated further if crises in the homeland generate demands from Governors for military support to civil authorities, which are also not well captured in the force planning process—or, if considered at all, assumed to be "lesser-included" cases. These phenomena create stress on the force that could be mitigated with more realistic force structure planning regarding steady-state peacetime missions including those at home, better management of CCDR demand, and more efficient balance and utilization of the Active and Reserve Components.

The current force-planning process, coupled with the high cost of some systems, has caused a decades-long shortage of high-demand, low-density assets, such as U-2 and J-STARS. For such assets and several other mission areas, the steady state has been more stressful than the wartime requirement. It would take tectonic shifts in the DoD planning process to account more realistically for manpower and systems required to meet steady-state requirements. Accordingly, the Commission has taken the force planning process as it is, but recognizes that the steady-state world is demanding of force structure. The best available cost-effective solution is to increase Reserve Component capacity to meet peacetime surges and to relieve the demands on the Active Component. A rotational force structure that includes significant use of the Reserve Components would help meet these requirements.

### Guiding Principles of Force Structure, and Force Management

The Commission determined the following principles of force structure and force management that will allow the Air Force to meet present and future mission requirements within the limit of resources the Commission believes will be available.

#### Principles of Force Structure

- Both the Active and Reserve Components provide unique value to the nation. The Total Air Force cannot succeed without three strong components. Prudent reductions in the Active Component will produce meaningful cost-savings, mainly in the military personnel accounts, and can reduce the need for cuts to readiness, modernization, and recapitalization.
- The Air Force can maintain operational capacity and capability

and reduce stress on the Active Component by maintaining or increasing the end strength of the Reserve Components, particularly in part-time Reservists and Guardsmen, and increasing the regular, periodic, and predictable use of those forces.

- Greater reliance on a larger Air Reserve Component provides a quickly reversible way to take manpower cost savings, maintain the ability to surge combat capability when needed, and gain additional return on investment of high-cost, high-value training received by Active Component Airmen. It also maintains a link to communities and states throughout the nation in our unique form of federalism.
- In order to gain maximum benefit from the Reserve Components, the Air Force must program sufficient operational support funding to

## NOBLE EAGLE

Traditional Guardsman Lt Col Tim Duffy and Maj Dan Nash, a full-time Guardsman, were ordered to scramble their F-15 Eagles at Otis ANG Base, Mass., at 8:46 a.m. on Sept. 11, 2001. Five minutes earlier, having heard of a potential hijacking, they suited up and already were heading for their jets when the klaxon sounded. Lt Col Duffy actually had real-world experience, having intercepted a hijacked Lufthansa flight in 1993.

When they took off less than a minute later, what would become Operation Noble Eagle began. In the ensuing six months, Guard, Reserve and Active fighter pilots flew more than 19,000 sorties compared with 147 sorties in the previous year. Through April 2013, Noble Eagle logged 64,000 total sorties, 65 percent flown by Air Reserve Component pilots.

However, the air defense mission, which numbered about 1,200 interceptors in 1960, was nearly eliminated in the mid-1990s when the need for homeland air defense seemed unnecessary in the post-Cold War years. On Sept. 11, 2001, the responsibility for immediately defending continental U.S. airspace was in the hands of 14 aircraft standing alert at seven sites. Two sites were in the Northeast Air Defense Sector, at Otis and at Langley AFB, Va., each with two aircraft.

Though Lt Col Duffy and Maj Nash had been ordered to scramble and others would soon receive similar orders, some 60,000 Guards-

men followed their militia principles, put their civilian obligations aside, and reported for duty that day. National Guard Airmen would fly 179 missions that day.

Among them was Col George Degnon, Director of Staff for the National Commission on the Structure of the Air Force. Then a major in the 121st Fighter Squadron, 113th Wing, District of Columbia Air National Guard, he flew F-16s out of Andrews AFB. His civilian job was as a first officer with United Airlines, but on Sept. 11, 2001, he had the day off. He heard of the attack on the World Trade Center as he and his wife were returning home from dropping their two children off for their first day of school. "I saw F-16s flying up the Potomac on TV and realized it was time to call the squadron." He was put on crew rest—"I tried to nap, but that was useless"—before heading to Andrews at 5 p.m.

"I wound up flying two times that first night, the first a 3½ hour sortie on night vision goggles and the second a two-hour sortie during dawn." The first sortie he was sent to check on an "unknown rider," which turned out to be a state trooper helicopter landing at Manassas. For a week Col Degnon pulled the graveyard shift. "On the late nights it was some eerie flying. We were capping (combat air patrol) over Washington and Camp David. I was able to see water flowing into the burning Pentagon and see all of the devastation as I capped overhead."

permit utilization of individuals and units through volunteerism or under the authority of 10 U.S.C. § 12304b.

- Increasing Active-Reserve integration of headquarters and units as well as increasing the number of integrated or multi-component (“associate”) units will lead directly to improved processes and more effective and efficient employment of the Total Air Force.

### Principles of Force Management

- Removing numerous barriers to a “Continuum of Service,” in which Airmen have greater flexibility to leave and re-enter Active and Reserve service throughout their careers, will enable more effective and efficient utilization of an integrated Total Air Force. Some of those barriers are contained in law, but others reside solely in service policy, tradition, and culture.
- In addition to removing barriers to transitioning between components, Congress and the Department of Defense should modify laws and regulations that unnecessarily limit or restrict the length of service by qualified Airmen. Doing so will allow the Air Force to capitalize more fully on the cost of training those Airmen.

### Contentious Related Issues

The Commission also learned that even large military personnel and force structure reductions cannot completely close the budget gap created by anticipated funding levels, especially

for an Air Force that is transitioning to modern, multi-role aircraft and still in possession of an installation infrastructure that was built for a much larger force than exists today or should, in the Commission’s view, exist in the future. Instead, personnel and force structure cuts lead to inefficiencies as dwindling forces are spread in too small numbers across multiple bases.

Accordingly, the Commission addressed three issues that some have described as “third rails” of force structure. The Commission felt it would not be true to its charge from Congress if it did not do so.

- To provide more coherence between force structure as planned and day-to-day force management, and to mitigate stress on the force, the Commission recommends that Combatant Commanders not be permitted to take an unconstrained view as they plan for the employment of air power for contingencies or steady-state operations in their theaters. There is, and will be, only a finite amount of air, space, and cyber power the Air Force and its people can provide. Force planning “demand” must take into account the reasonable “supply” of capability available.
- The Commission recommends that both the Air Force and Congress consider ways to reduce the infrastructure footprint that the Air Force must maintain, giving due consideration to the importance of community presence and the vital role played by the National

Guard in carrying out missions for Governors, the other commanders in chief in our federal system.

- If the Air Force determines that the elimination of entire aircraft fleets or other missions is required, the Commission recommends the development of a comprehensive plan that specifically addresses the locations and capabilities involved, the plan for the future utilization of the Airmen affected, and the means by which the mission capabilities that are lost will be replaced, if they will be replaced, and when that replacement will occur to ensure no gap in war-fighting capabilities.

In the chapters that follow, this report will address specific findings and recommendations regarding resources, force structure, and force management. ▶

*For additional detail refer to:*

Appendix A: The statute forming the National Commission on the Structure of the Air Force

Appendix B: The full list of the Commission’s recommendations

Appendix C: The officials responsible for implementing the Commission’s recommendations

Appendix F: The full list of Commission hearings, site visits, and staff visits

Appendix G: Individuals who testified and provided oral comments to the Commission

Appendix H: Glossary of terms and acronyms





“Today we face the danger that our current budget crisis and the steep, abrupt, and deep cuts imposed by sequestration will cause an unnecessary, strategically unsound, and dangerous degradation in military readiness and capability.”

*Secretary of Defense Chuck Hagel in a speech delivered to the CSIS Global Security Forum, Nov. 5, 2013*

## CHAPTER 2

# RESOURCES

The Department of Defense, like the rest of the federal government, experiences budget reductions, especially in times of austerity and following periods of war when hostilities are winding down. Nonetheless, a decade of war has taken a heavy toll on weapon systems, equipment, and personnel. DoD must recapitalize and, in most cases, modernize old and battle-worn equipment for future threats. Because the Commission anticipates that over the next ten years funding levels are not likely to rise much above those specified by the Budget Control Act (BCA) and Sequestration, the Air Force must find innovative ways to manage its resources.

In order to make responsible changes to resource management, the Air Force must have accurate and

consistent ways to measure costs. The Air Force must also be allowed the flexibility to manage its various accounts in ways that optimize effectiveness and maximize efficiency. Heretofore, Congress has constrained the military from taking a holistic and strategic approach to managing this necessary down-sizing by prohibiting cuts in accounts such as installations. These constraints drive greater cuts to modernization and readiness than a more flexible approach would and thus increase operational and strategic risk.

### Operational Support

Elsewhere, this report explains why the Commission believes that greater operational use of the Air National Guard and Air Force Reserve (together referred to as the Air Reserve

Component or ARC) can mitigate the risk and potential stress caused by reducing Active Component end strength. The Commission repeatedly has heard formal and informal testimony, supported by written reports from Air Reserve Component leaders, that the ARC can do more if sufficient funding is provided. The Commission also has received testimony that “man-day” or “man-year” funding, originally in the base budget to fund Air Reserve Component support for active duty missions, sometimes has become unavailable to operational commands because it is transferred to meet other priorities.

If the Air Force Reserve and Air National Guard are to contribute in the manner the Commission recommends, it is important that budgetary plans

are made for that use and that controls exist to ensure that the funds are executed as planned. Utilizing the part-time or traditional members of the Reserve Components on a rotational basis of approximately 1:5 (one period of active duty followed by five times that duration on traditional Reserve duty) would provide the Air Force with more than 18,000 additional man-years of service annually. In the integrated Total Air Force model the Commission recommends, such service could be provided both by individuals and units and would be in addition to the service already provided by Airmen who serve as Active Guard and Reserve (AGR), Air Reserve Technicians, and Federal Technicians.

### Cost Methodologies

The Commission has learned through testimony and research about various methodologies for computing cost of personnel and operations beyond annual appropriations and outlays (for example, Military Personnel TOA seen in Figure 1). The Commission concluded that no one model incorporates all significant factors and satisfies all the measurements needed to make force structure decisions. The Commission also concluded that continuing to experiment on ways to modify various cost modeling tools in search of a perfect model is not productive.

The Reserve Forces Policy Board (RFPB) conducted a study that sought to capture the “fully burdened cost” of Active Component and Air Reserve Component personnel. Its basic premise was that all elements of personnel costs—for example, salary, child care subsidies, commissaries, DoD schools, retirement pay accrual, health care, installation costs, and contributions by other government agencies such as the Veterans Administration—should be considered when trying to determine the actual

## DEFINITIONS

### RECAPITALIZATION

Replacing an existing weapon system with another weapon system. Frequently, the new weapon system is more modern than the existing weapon system.

### MODERNIZATION

Updating an existing system to improve operational capability or technical performance.

### MAN-DAY

Military funding paid to Reservists to perform duty over and above their minimum number of days for inactive duty training and annual tour. Each Man-Day pays the member one day’s base pay, housing allowance, subsistence allowance, and other appropriate military pay entitlements.

### LIFE-CYCLE COSTS

(1) The total cost of a piece of equipment from its development, fielding, and sustainment through retirement. (2) The total cost of an Airman in service to the nation, from entry into service through death, including the costs of training, service, and benefits.

### HOLLOW FORCE

A military force that appears mission-ready but, upon examination, suffers from personnel, equipment, and maintenance shortages or from deficiencies in training.

### WARM BASE

An installation or part of an installation without permanent operational forces; such installations are maintained at a level that will allow rapid re-occupation by operational forces.

cost of utilizing a component. The RFPB Chairman testified that its approach to this question was driven by what it considered the inadequate and misleading approaches to personnel costs currently used.

Both the RFPB’s Chairman and its Military Executive testified and conceded that the question of which specific elements should be included in calculating the fully burdened cost was not settled. Their main recommendations were that DoD adopt a fully burdened cost approach to calculating the true cost of personnel, and that the Department should publish a specific methodology for use in calculating that cost. In

responses to Commission requests for information, the Department of Defense Director for Cost Assessment and Program Evaluation (CAPE) indicated agreement with the principle of accepting a fully burdened cost approach, but disagreed with the RFPB as to what particular elements of cost should be included in such a calculation.

In the Commission’s own examination of cost methodologies, it also found that most approaches to measuring cost do not connect expenditures with common measures of military outputs, further complicating the application of differing cost approaches. In other words, each

approach to measuring cost does some things and does not do some things, and, in large part, the differences are related to differing assumptions and output metrics.

The Commission concluded that simply measuring the payroll cost of an individual service member is inadequate. “Life-cycle” or “fully burdened” cost that includes benefits and retirement for personnel must be considered. Moreover, how the nation intends to employ Active Component and full- and part-time Air Reserve Component personnel as a Total Force will affect the comparative cost of a given force mix. In addition, the Air Force must perform certain core functions, such as procurement and RDT&E (Research, Development, Test, and Evaluation), that support all components of the Air Force. Those costs must be accounted for but are not easily allocated to any one component.

The Air Force has taken significant steps to adopt a fully burdened

cost approach with its Individual Cost Assessment Model (ICAM), initially developed by the Air Force Reserve as an effort to provide a tool to estimate burdened life-cycle and annual manpower cost for the three-component Air Force. ICAM is a simulation that models individual Airmen over time along the myriad possible career paths beginning with accession and ending at separation from the Air Force (prior to earning retirement benefits) or death.

Notwithstanding differences in recent efforts to compare the cost of the Active Component against the Reserve Components, the Commission concluded that there is a consensus that a part-time force used on an individual or rotational basis should be significantly less expensive on a fully burdened basis than an Active force of equal size. Beyond the obvious point that part-time Airmen get paid only when they are in training or supporting real-world missions, there are several

other considerations.

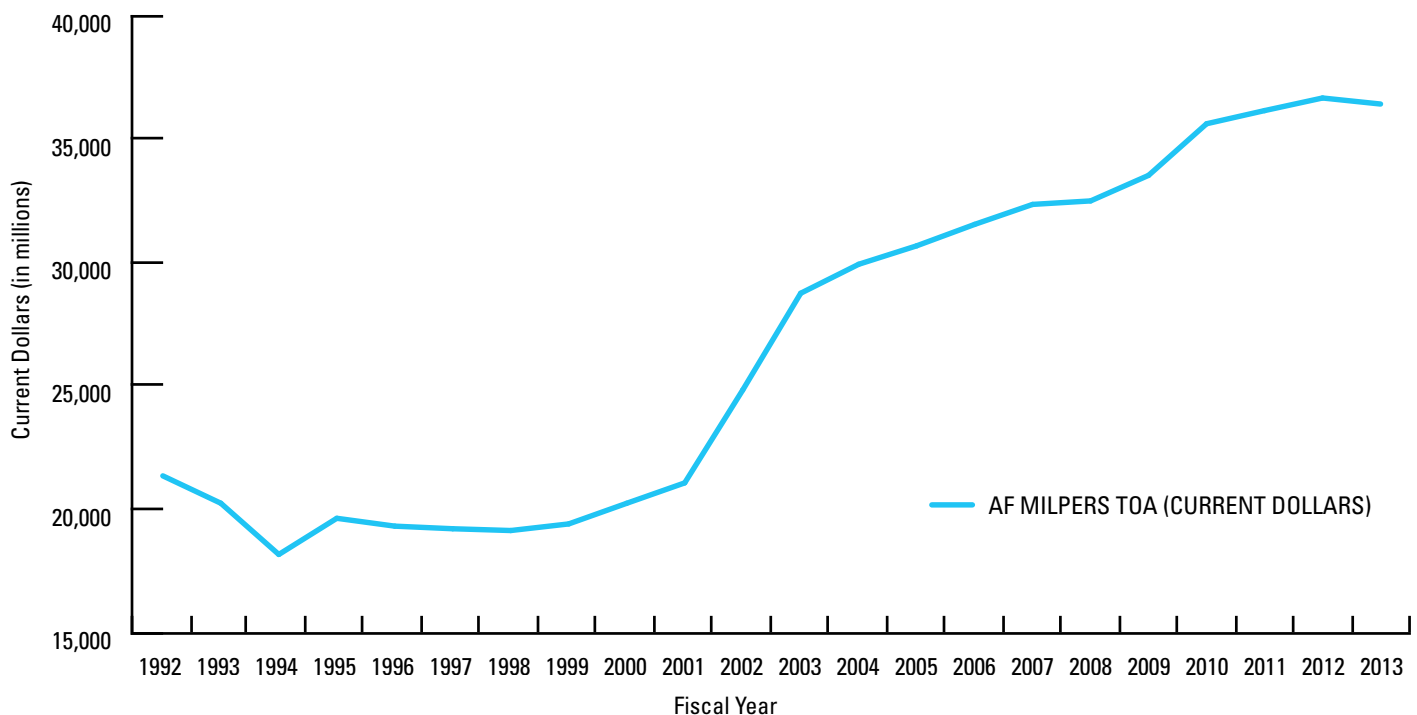
First, Air Reserve Component forces are required to train fewer Airmen “from the ground up”; instead, the Reserve Components benefit from being able to acquire seasoned Airmen from the Active Component.

Second, seasoned Airmen require less periodic training to retain wartime skills. In particular, Reserve Component flying squadrons can maintain proficiency with fewer flying hours per month than an Active unit, which amounts to tens of millions of dollars in savings each year.

Third, Reserve Airmen sometimes have civilian occupations in fields closely aligned to their Air Force jobs, which also reduces costs associated with maintaining military skills. This is the case in areas as diverse as medicine and cyber defense.

Fourth, Reserve Airmen cannot receive retirement pay until age 60 and are generally not supported by Air Force-supplied housing, child

FIGURE 1: **Air Force Military Personnel TOA**



Data from the Air Force’s FY 2014 President’s Budget Submission (<http://www.saffm.hq.af.mil/budget/>).



care, schools, health care, and Morale, Welfare, and Recreation facilities.

There are, of course, some offsetting costs, such as the full-time pay of AGRs and Technicians who support Reserve units administratively and for training, in addition to the higher pay levels generally associated with more experienced forces. Compared to the Army, the Air Force has a greater proportion of its Air Reserve Component personnel on full-time duty. This level of full-time manning merits further analysis for the potential of additional cost savings.

Based on the record before the Commission, and subject to all the caveats set out above, the Commission determined that the cost of a traditional Reservist, who is not performing active duty missions during a year, is approximately 1/6th the cost of a full-time Active Component Airman. Much more work can, and should, be done by DoD to arrive at an accepted measure of cost. Equally important, the costs of both Active

and Reserve forces are essentially the same when each is providing full-time service. Therefore, the significant cost savings attributed to Reserve forces are only possible when those forces can be used on less than full-time basis until mobilized for a national emergency.

#### **Pay and Benefits**

As the DoD's Comptroller, Robert Hale, testified to Congress in 2012, "The cost of pay and benefits has risen more than 87 percent since 2001." Figure 1 on Page 23 illustrates the increasing Military Personnel costs for the Air Force over the past two decades. Such increases compete with modernization and readiness and necessitate more cost-effective utilization of the Total Force, including reductions in personnel spending.

Thus, the Commission supports the recent establishment of the Military Compensation and Retirement Modernization Commission and anticipates that its conclusions will find savings by leveraging best

business practices for retirement and benefits while still keeping faith with our Airmen and their families. The Commission's recommendation to rebalance the Active Component and the full- and part-time Reserve Components should also create efficiencies in personnel accounts. These efficiencies should provide some relief to the resource pressure on readiness, modernization, and recapitalization imposed by the perfect storm of increasing personnel costs and declining Defense budgets.

#### **Infrastructure and Installations**

Shifting to a Total Force that is more reliant on the Reserve Components and characterized by more integrated associate units will have implications for installations. For example, associating an Active unit with a Reserve unit (or vice versa) will allow collocation of personnel and consolidation of support infrastructure. Greater utilization of Air National Guard bases is inherently less expensive because those bases tend to have fewer non-operational facilities than Active Component installations do.

The Commission recognizes that movement of Active Component force structure to more austere bases at which assigned personnel and their families utilize community-based support services could have implications for retention. The Commission did not receive specific data on that question, but acknowledges it as one of many considerations involved in the review of infrastructure adjustments.

Likewise, the proposed divestitures of complete aircraft fleets will have obvious implications for the bases where those aircraft are located. Ignoring personnel shifts and reductions and attempting to operate the same number of bases at the same level of effort will require cuts to readiness funding accounts. Warm-basing may, in some cases, be a better,



more cost-effective option than closing bases as it can save in conversion costs while also leaving infrastructure available for future contingencies. However, without authorization from Congress to warm base or close installations, the Air Force would lose the financial advantages gained by the force structure reductions this Commission recommends.

Air Force leaders repeatedly have pointed out that the Service already has significant excess infrastructure. The trends described in this report, combined with any divestitures of complete aircraft fleets, likely will

increase that imbalance. Moreover, increasing the number of associate units will allow consolidation of support infrastructure, which would create added efficiencies.

Additional mitigation of the stress on a smaller Active Component force could be achieved by reducing the total amount of infrastructure at some selected CONUS bases. In the near term, the Commission believes that can be done within authorities currently available to the Air Force by moving some force structure from Active Component installations to neighboring Air National Guard

installations that have sufficient existing capacity to absorb additional force structure.

Many Air Reserve Component bases have the infrastructure in place to absorb more aircraft, equipment, and the attendant manpower. The Air Force built these bases in such a way that they could handle a squadron the size of an Active Component squadron. Typically, Air Reserve Component mobility squadrons have eight aircraft compared to Active Component squadrons of 12, while Air Reserve Component combat squadrons have 18 aircraft compared to Active

## THE GROUNDING

First Lieutenant Paul M. Baker arrived at Hill AFB, Utah, in February 2013 with about 80 flying hours at the F-16 Basic Course and was assigned to the 4th Fighter Squadron of the 388th/419th Total Force Integration (TFI) Fighter Wing. Less than two months later he was grounded. The reason: Sequestration.

The automatic budget cuts that went into effect last April under the Budget Control Act prompted the Air Force to stand down 17 Combat Air Force squadrons. Air Combat Command (ACC) chose to ground units furthest from being tasked by Combat Commanders, and because the 4th FS had just completed a PACOM Theater Security Package deployment, it made the list.

The stand-down lasted 3½ months, during which time the squadron's 24 assigned pilots and aircraft were unavailable for any missions. Though they continued classroom and simulator training, pilots could not maintain their readiness levels without actually flying. Thus, the grounding's impact lasted long after July 15 when ACC authorized the 4th to return to the skies. To be considered combat mission ready (CMR), an inexperienced F-16 pilot must fly 10 sorties per month or have flown 30 sorties in the past 90 days; an experienced pilot must fly eight sorties per month or have flown 24 sorties in the past 90 days. The basic mission capable (BMC) rate is five sorties per month for experienced pilots and six sorties per month for inexperienced pilots. The sortie total is termed "look back," and each month the squadron commander assesses each pilot's 30-day look back; if the pilot has not met the 30-day look back, they can still meet the 90-day look back minimum to be considered CMR.

With the help of the attached 388th FW instructor pilots and the Reserve instructor pilots in the 419th Fighter Wing (AFRC), the 4th

began its three-ride reconstitution spin-up program on July 16. It took until the end of August for 21 pilots to achieve CMR. That number fell to 18 in September when the end of the Fiscal Year 2013 Flying Hour Program limited the number of sorties available. "Since there was only one half of a month of flying in July, no 4th FS pilot had the 90-day look back to make them CMR when they did not meet the 30-day look back requirement," said 4th FS Commander Lt Col Todd "T-Bone" Robbins.

The 4th FS stood down again on Oct. 1 for eight days because of the government shutdown. "With the loss of eight operations and maintenance days, again only 18 pilots of 23 achieved CMR status," Lt Col Robbins said. "Consequently, the 4th FS could not be considered CMR as a whole by all readiness standards."

That the 4th even achieved the readiness level it did in August was due to the performance of the 4th Aircraft Maintenance Unit, "who surpassed expectations in terms of sortie production," Lt Col Robbins said. "However, since the initial return to fly, the 4th FS CMR status has been very tenuous because the squadron does not have the long-term readiness levels to fall back on when additional training disruptions occur, such as the eight-day stand-down in October."

The stand-down's impact on individual pilots such as 1st Lt Baker could be far reaching. During the time he was grounded due to sequester, his peers at other F-16 squadrons accomplished 60 to 80 flying hours of training. That means Lt Baker is 30 percent to 50 percent less experienced in the F-16 cockpit compared to his peers. "This individual effect has a disproportionate impact on inexperienced pilots' ability to survive in a combat environment because they lack a broad experience base," Lt Col Robbins said.

Component squadrons of 24. This presents an opportunity to realize efficiencies by shutting down or warm basing an Active Component base and increasing the footprint at nearby Reserve Component bases.

For example, Mountain Home AFB, Idaho, has shrunk to only two Active Component F-15E squadrons with a total of 45 aircraft. Nearby Boise ANGB currently has one squadron of 18 A-10s. A divestiture of the A-10s would present an opportunity to move up to 24 F-15Es to the Boise ANGB base in an integrated wing construct. The remaining F-15Es at Mountain Home could be moved to another location.

#### ■ RECOMMENDATIONS

**1. Cost Approach:** DoD should formally adopt the “fully burdened cost” approach to calculating military personnel costs, and it should apply analytic methods that focus on appropriate outputs along with life-cycle costs. The Department should then modify DoD Instruction 7041.04 to establish a common list of the

various elements of pay, benefits, and other costs that contribute to the “fully burdened” or “life-cycle” cost that all services would then use in calculating the cost of personnel. This will enable the Air Force to accurately assess force structure issues and choices in terms of fully burdened, total life-cycle costs of human capital, as well as operating costs of units and aircraft.

**2. Budgeting Flexibility:** In the Fiscal Year (FY) 2015 National Defense Authorization Act and Defense Appropriations Act, Congress should allow DoD increased flexibility in applying budget cuts across budget categories, including installations.

**3. Resourcing the Reserve Components:** To ensure the Air Force leverages full capacity of all components of the force, in its FY 2016 Program Objective Memorandum, the Air Force should plan, program, and budget for increased reliance on the Reserve Components. The Commission recommends: (1) the Air Force should include in all future

budget submissions a specific funding line for “operational support by the Air Reserve Component” to clearly identify those funds programmed for routine periodic employment of the ARC either as volunteers or under the authority of 10 U.S.C. §12304b; (2) in its future budget submissions the Air Force should program for approximately 15,000 man years of operational support annually by the Air Reserve Component; (3) in succeeding years, the Air Force should monitor the execution of this program element to ensure it is utilizing the Air Reserve Component to its fullest extent.

**4. Infrastructure:** The Air Force should consider, and Congress should allow, the closing or warm basing of some installations. ▶

*For additional detail refer to:*

Appendix I: Charts on war and post-war spending cycles and Air Force end strength over time.



”You can’t surge trust.”

*Lieutenant General Bradley A. Heithold, Vice Commander, U.S. Special Operations Command, in an interview with National Commission on the Structure of the Air Force staff, Oct. 29, 2013*

## CHAPTER 3

# REBALANCING THE COMPONENTS

Since the end of World War II, the nation has maintained separate identities for the National Guard and Reserves despite several attempts at merger. Notable among them were the Gray Board of 1947 that recommended abolition of the National Guard, and Secretary of Defense Robert McNamara’s attempt in 1964 to merge both Reserve Components of the Army under the National Guard. Defense Secretary James Schlesinger’s introduction of the Total Force Policy in 1973 created momentum to integrate Reserve forces with Active Component forces, increasingly blurring the distinctions among the components. Each reform attempt has triggered strong opposition from some individual, organization, or faction.

In contrast, ever since the first

large mobilization of the Reserve and National Guard in 1990, the Air Force steadily has embraced the evolution and, ultimately, total transformation of its Reserve Components from a ready, but essentially strategic, reserve force to today’s operationally capable and readily available force. Nevertheless, the Commission is convinced that the Air Force must change the way it organizes, functionally integrates, aligns, and employs the great Americans who volunteer to serve in its ranks.

Within each component, the Commission observed an increase in headquarters structure and staff. The growing size and number of these headquarters increases tail, and the stovepipe nature of each component further insulates them from greater and healthier integration. Increasing

integration of headquarters and units and the number of associate units will lead directly to improved processes and more effective and efficient employment of the Total Air Force.

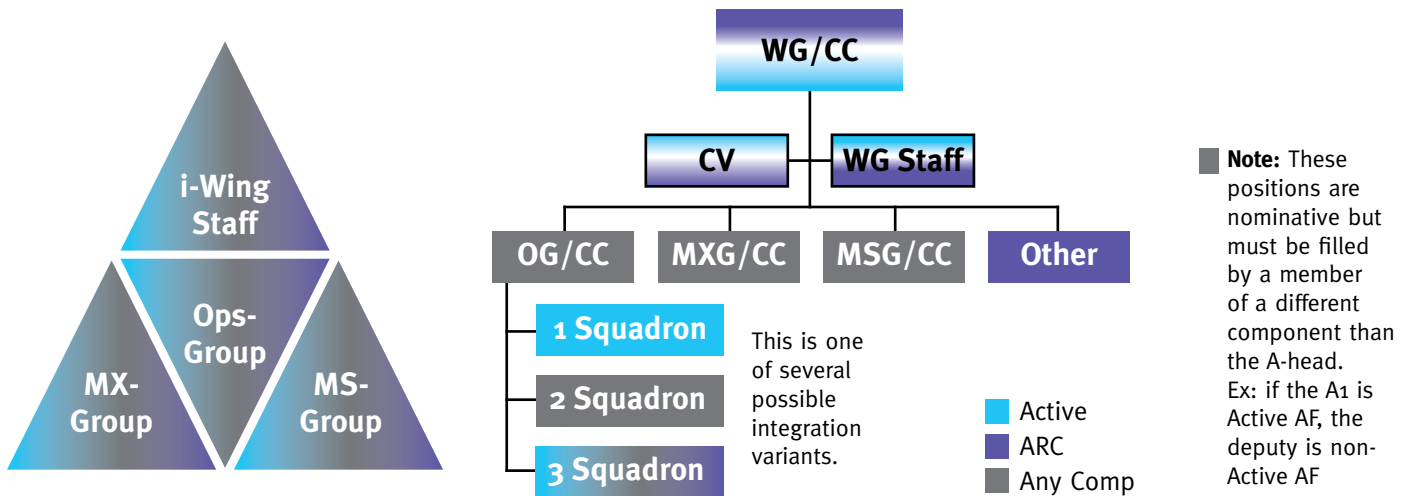
Successful integration will demand steadily increasing trust among Airmen at all levels of all components. The bonds of confidence that Airmen have built over more than a decade of service in war make it reasonable to believe that the necessary levels of trust among the components can be achieved and maintained.

### Component Associations

As early as 1968, the Air Force broke new ground by “associating” an Air Force Reserve unit with an Active Component unit. The two units flew and maintained the same aircraft,



FIGURE 2: i-Wing Integrated Leadership



achieving efficiencies by increasing the crew ratio and thus the ability to utilize those aircraft. But they remained separate, collocated units. The Air Force now has 120 current or planned associate units.

Most of these units follow the original “classic association” model in which Air Force Reserve units collocate with Active Component units. A relatively small number involve “active” associations in which detachments of Active Component pilots and maintainers jointly operate aircraft on an Air National Guard base. Sometimes the Active Component personnel are permanently based at the Air Guard installation; in other cases, the Active Airmen commute from a nearby Active installation for duty at the Air Guard base. A few other active associations involve additional permutations of this mix of Active and Guard talent. In another type of association called the Air Reserve Component or ARC Associate unit, Air National Guard and Air Force Reserve units are collocated and share equipment that is owned by one or the other unit.

Commissioners visited associate units of each type and found them

to be generally successful. However, the Commission concluded that opportunities remain for continued growth and improvement of the associate unit concept.

ARC associates generally have been the least successful model. Where they operated the same aircraft, the two Reserve Component units competed for the same geographic pool of potential recruits. Such associations also create potential problems of access to Title 32 personnel and equipment during state emergencies.

Classic and Active associate units have not achieved their full potential because they continue to maintain dual chains of command. This unnecessarily increases overhead and creates, at least, the potential for divided loyalties that hold back the development of trust that should characterize a well-led and tightly bonded unit. The Commission also noted that fewer active associate units exist despite the fact that the Air National Guard maintains more units than the Air Force Reserve.

#### The i-Wing

The Commission concluded that two major changes should occur. The

first is an increase in the overall number of associate units. The Commission believes that a “default position” should be that a unit of the Active Component or the Air National Guard should have an associate relationship with an element from another component, unless a substantial reason exists that prevents the formation of a classic or active association.

Secondly, the Commission believes that associate units should have a single, integrated chain of command. For the purposes of this discussion, this report calls these integrated units “i-Wings” (Figure 2).

Increasing use of integrated units, coupled with the changes in Active and Air Reserve Component end strengths, as recommended elsewhere in this report, will enhance the ability of the Air Force to scale its available forces to meet constantly changing demands. i-Wings with significant Air Reserve Component members can be adjusted to meet current demand by adjusting the man-year funding and the opportunities offered to RC Airmen to serve on active duty. Doing so allows easy adjustment to the number of crews, maintainers, or other operators

so that the i-Wing's capability can be scaled to meet demand.

i-Squadrons could be structured with Reserve flights and Active Component flights or could just as easily be fully integrated. A squadron would be manned with Active, full-time Reservists, and traditional Reservists, the composition determined by the Major Command (MAJCOM) and based on the projected wartime and peacetime operating tempo of that unit. For example, the C-17 active-to-ARC crew mix is currently 3.0 active to 2.0 ARC. As the nation reduces its presence in Afghanistan, and with it the probable reduction in peacetime airlift, the need for the high number of Active crews should go down, and the crew ratio could shift more heavily toward the ARC. So, the C-17 squadron could change its composition to a greater percentage of traditional Reservists for the foreseeable future, reducing costs while still able to meet peacetime needs. It also would retain the capability to be recalled for major military responses.

The additional benefit is to the Airmen, who can stay with their weapon system and location to a greater extent by being allowed to move freely among Active, full-time Reservist, and traditional Reservist statuses based on the needs of the Air Force. This open passage will significantly aid retention of our Airmen and reduce stress on the families.

Because legal issues (Titles 10 and 32) as well as administrative control and operational or tactical control issues still need to be resolved, the Commission believes a number of i-Wing pilot programs should be conducted before moving the entire force in this direction.

The Commission recommends that in the i-Wing, unit leadership positions, both officer and enlisted, be filled by personnel of both components

that make up the associate unit, and the unit operate as a single entity rather than two, side-by-side commands. The Commission recognizes that while this organizational structure creates a leaner and more efficient structure, it also reduces the number of command and leadership opportunities. Air Force leadership must carefully manage the implementation of this

concept to ensure the fair allocation of opportunities. Failing to do so will destroy the trust relationship potential of the i-Wing.

Notwithstanding these risks, the i-Wing is a logical extension of the forward-thinking approach first instituted by associate units. Truly integrated units can create new opportunities for Air Reserve



## DEFINITIONS

### STRATEGIC RESERVE

A Reserve force intended for use during later stages of a protracted or large-scale operation but not on a day-to-day basis.

### OPERATIONAL RESERVE

A term used to describe the current situation in which the Air Force holds Reserve Component forces to the same standards of readiness as the Active Component, and regularly rotates these forces onto active duty service, whether in times of war or in peacetime. Joint Publication (JP) 5-0 defines Operational Reserve as an "emergency reserve of men and/or materiel established for the support of a specific operation."

### CLASSIC ASSOCIATION

An integration model that combines Active and Reserve elements, with the Active Component retaining principal responsibility for a weapon system and sharing the equipment with one or more Reserve Component units. Today, the Active and Reserve units retain separate organizational structures and chains of command.

### ACTIVE ASSOCIATION

An integration model that combines Active and Reserve elements, with the Reserve Component retaining principal responsibility for a weapon system and sharing the equipment with one or more Active Component units. Today, the Active and Reserve units retain separate organizational structures and chains of command.

### AIR RESERVE COMPONENT (ARC) ASSOCIATION

An integration model that combines two Reserve Component elements, with one retaining principal responsibility for a weapon system and sharing the equipment with one or more of the other component's units. Today, the units retain separate organizational structures and chains of command.

### TRADITIONAL RESERVIST

A member of the Air Force Reserve who drills one weekend per month and two weeks per year. A traditional Reservist may be activated for contingency operations or extended assignments.

Component leaders and increased opportunities for Active Component Airmen to gain knowledge and confidence in the capabilities of the Reserve Components. With

appropriate revisions of some restrictive statutes and policies (see Appendix J), such units will increase the opportunity for mentorship and collaboration among Airmen of differing experience

levels. I-Wing units create additional opportunities for Air Reserve Component personnel to deploy on a regular and recurring basis, making better use of their capabilities, keeping those capabilities sharp, and reducing somewhat the frequency and duration of deployments by Active Component personnel.

Increased unit associations also will aid in proportionally and concurrently fielding new equipment. Instead of a “trickle down” approach in which older equipment is assigned to Air Reserve Component units as it is replaced by modern equipment in the Active Component, the Commission believes that new equipment should be “horizontally” fielded across all components annually. Current fielding plans for the KC-46A appear to follow a somewhat similar approach, while the current plans for the F-35 fall considerably short of this recommendation.

## INTELLIGENCE, SURVEILLANCE, AND RECONNAISSANCE



The Air Force rapidly expanded its manned and unmanned Intelligence, Surveillance, and Reconnaissance (ISR) capabilities and capacity over the past decade of war. It increased the number of Predator orbits in theater, improved the aircraft’s capabilities, fielded the Global Hawk and MC-12 Liberty aircraft, revived the U-2 program, and expanded the Distributed Ground System (DGS) footprint. The Air Force no longer views ISR as combat support; it is one of the five core mission. ISR manning mirrors that of the Total Air Force with 64 percent in the Active Component, 30 percent in the Guard, and 6 percent in the Air Force Reserve.

Much of the ISR progress has been focused on sensors and collection to meet an insatiable demand for intelligence at all levels, from strategic planners to the platoon patrolling a city block. While both quantity and quality of sensors and collection has expanded, advances in the processing, exploitation, and dissemination (PED) of the data being collected—turning it into actionable information to be distributed to the ultimate users—has lagged. The sheer volume of collected data is driving a demand beyond the capacity of the Active force and requires augmentation that can be provided, full- or part-time, by the Reserve Components.

Reserve Component augmentation can be adjusted like a rheostat; increased when demand is high and decreased as demand drops. To that end, the Air Force in December 2013 activated two Air Force Reserve intelligence squadrons at JB Langley-Eustis, Va. The 63rd IS, reporting to the 480th ISR Wing and the 497th ISR Group, is responsible for operating the DGS-One, allowing it to exploit near real-time data from the U-2, RQ-4 Global Hawk, MC-12 Liberty, MQ-9 Reaper, and the MQ-1 Predator. The 42nd IS supports current operations and contingency planning by providing products to the 36th Intelligence Squadron and the Air Force Targeting Center at JB Langley-Eustis.

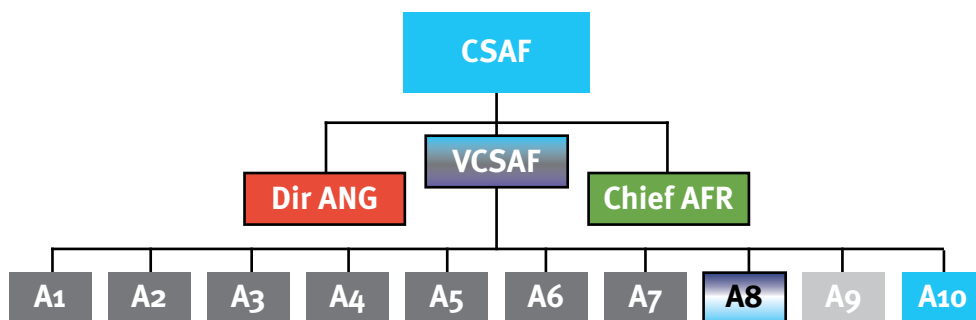
Because the intelligence community is globally connected, PED is a suitable mission for the Reserve Components, which can deploy in place and conduct operations with minimal disturbance to home life and employers.

### Integration at HQ Levels

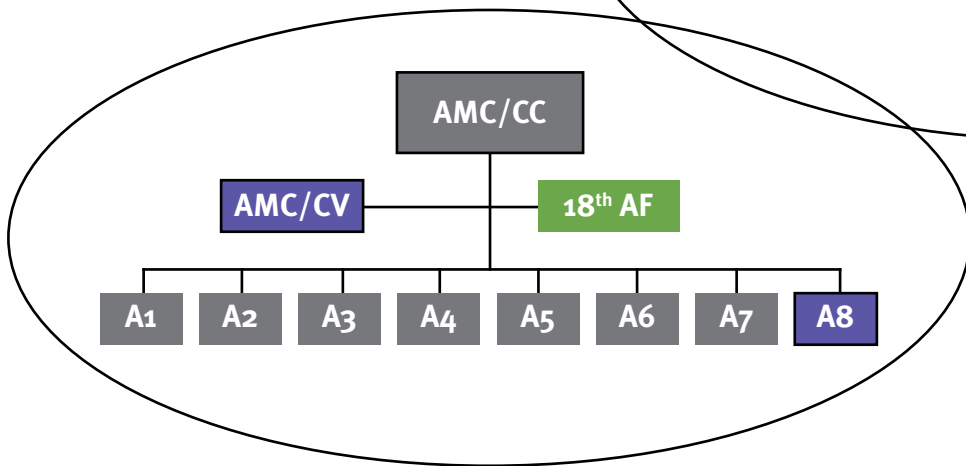
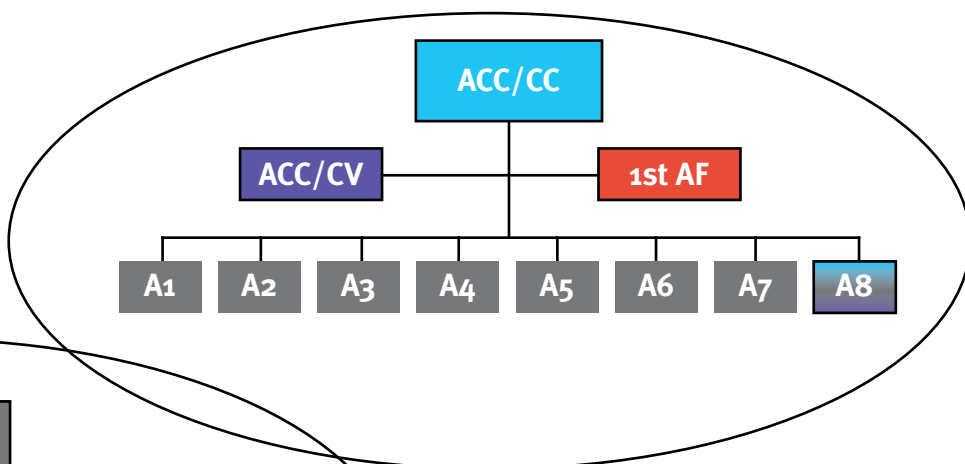
The Commission received testimony from the leaders of the Air Force’s Total Force Task Force regarding a concept of individual integration of personnel from all three components at headquarters staffs. The Commission supports those initiatives, but with some revision. The Commission sees no reason why key leadership and decision-making positions on those staffs should not be nominative. Again, the Commission believes that integration needs to be carefully managed to ensure that choosing the “best and fully qualified” does not become a route to exclude Airmen of any one component.

If the Air Force manages this process well, it will make full use of the talent available to it, and the process will produce more well-rounded, experienced leaders of all components for future assignments. Also, high-level decision making for the Total Air Force will be better informed by Air Reserve

FIGURE 3: Integration at the Corporate Level



**Note:** These positions are nominative but must be filled by a member of a different component than the A-head. Ex: if the A1 is Active AF, the deputy is non-Active AF



- Active
- ANG
- AFR
- Any Comp
- ARC
- Civ

Component perspectives.

However, as the Air Force progresses toward fuller integration at the unit level, the need for an Air Force Reserve Command as a “force providing” headquarters declines, as does the need for its subordinate Numbered Air Forces. Commanders of operational major commands (Air Combat, Mobility, Space, etc.) and their Numbered Air Forces can make decisions regarding the employment of integrated Air Force capabilities. The Commission believes the current mission of the Air Force Reserve

Command and its Numbered Air Forces can be disestablished. However, the requirement for knowledgeable policy-making and advice regarding the Air Force Reserve and Air National Guard will remain (Figure 3).

Accordingly, the Commission recommends the retention of the positions of Chief of the Air Force Reserve and Director, Air National Guard as three-star officers with direct access to the Chief of Staff and with small but sufficient staffs to allow them to properly advise Air Force leadership on policies necessary to recruit, retain,

and sustain talented and motivated Airmen in both the Air Force Reserve and Air National Guard.

The Commission believes that an enterprise approach to total Air Force integration can yield significant savings. Adopting the i-Wing construct could conservatively save more than 5,000 Active Component positions. That could result in savings of as much as \$2.8 billion over the Future Years Defense Program (FYDP). Integrating Mobility Air Force (MAF) wings offers the earliest and potentially greatest savings, though substantial savings



can be achieved with a like measure in the Combat Air Forces (CAF), Air Education and Training, and Cyber.

According to December 2013 Air Force Reserve data ([www.afrc.af.mil](http://www.afrc.af.mil)), the Air Force Reserve has real estate interests at 66 locations: five Air Reserve bases; four Air Reserve stations; as tenant at 42 Air Force locations, one ANG installation, four Army locations, and three Navy; four ranges; and three miscellaneous locations. The Air Force Reserve operates 33 flying wings, 12 flying groups, and one space wing; most are on Air Force bases.

Exploratory manpower analysis yields the following potential savings of fully integrating Air Force associated

units, such as Travis AFB, California (MAF), or Hill AFB, Utah (CAF):

- MAF i-Wing FT manning savings are about 200–300 FT billets;
- CAF i-Wing FT manning savings are about 100–200 FT billets.

Adopting the i-Wing construct could conservatively save 5,800 Active Component positions [5000 (25 tenant wings x 200) + (9 host wings x 30 = 270) + (28 other locations x 20 = 560)]. This is a savings of about \$560 million per year or \$2.8 billion over FYDP; i.e. 2 percent of AC manpower or approximately 2 percent of the total AC MILPERS account, which is \$28 billion in the Air Force's FY 2014 President's Budget Submission (<http://www.saffm.hq.af.mil/budget/>). For additional

information, see figure 4, Page 36.

## ■ RECOMMENDATIONS

### 5. Air Force Reserve Command:

Congress should amend 10 U.S.C. §10174 to retain the statutory rank, roles, responsibilities, and functions of the Director, Air National Guard, and Chief of the Air Force Reserve but disestablish the Air Force Reserve Command. The Air Force should inactivate the Reserve Numbered Air Forces, wings, and squadrons. The roles, responsibilities, and functions of disestablished organizations should be assumed by the Secretary of the Air Force, Headquarters Air Force, and MAJCOMS, all of which will have increased representation by Air Reserve

## REMOTELY PILOTED AIRCRAFT IN WILDFIRES

"We all remember the tragedy on June 30th in Arizona that claimed the lives of 19 young firefighters. Given the RPA's extraordinary victory in the Rim Fire this summer and the Air Force's success in having Air National Guard Reconnaissance Wings fly RPAs overseas in contingency operations, RPA force structure in the ANG must not only be continued, it is a moral imperative."

*Statement for the Record:*

Major General David Baldwin, The Adjutant General, California

California's 163rd Air National Guard Reconnaissance Wing flew into history last fall when it deployed its MQ-1 Predator to support firefighters battling the Rim Fire burning around Yosemite National Park. This was the first time a Guard RPA was employed for a Defense Support to Civil Authorities mission. The 163rd Predator launched on Aug. 28 from the Southern California Logistics Airport in Victorville. Capable of flying for up to 22 hours in a single sortie, the Predator captured real-time information that enabled officials on the ground to map the fire's location and progress and identify safe routes of retreat for firefighters battling the 160,000-acre wildfire. This time-sensitive data on the fire's behavior directly streamed to the incident commander on the ground and considerably improved firefighters' ability to contain the fire several

days earlier than originally anticipated.

The number of wildfires in the United States over the past 12 years have ranged between 67,000 and 92,000 per year. In the past year alone, wildfires burned more than 9.2 million acres. Civil authorities have been using satellites to provide imagery and assistance to firefighters, but satellite time is expensive and in high demand, and obtaining data can be cumbersome. With the right authorities and permissions, RPAs can provide continuous, near-real-time data in almost any area at a fraction of the cost of satellites.

Other benefits:

- RPAs can provide greater loiter time because they are not subject to manned pilot fatigue.

- From altitudes above 40,000 feet, RPAs are well away from the hazards of smoke and terrain that other aerial fire surveillance aircraft encounter.
- Forest Service regulations prohibit manned aircraft from flying during darkness, so firefighters are forced to fight fires blind after dark. RPAs can fly 24 hours per day, their sensors gathering and feeding data to firefighters around the clock. In fact, thermo sensors on RPAs can actually map fire lines with greater accuracy at night due to the earth's surface cooling.
- The large volume of data RPAs collect can help fire management experts better understand the science of giant fires.

In 2006, NASA operators flew the Ikhana, a civil variant of the General Atomics Aeronautical Systems Predator B in support of the Western States Fire Missions. Throughout the year, the Ikhana's operators used its thermal infrared sensors to map wildfires in six states on missions of up to 20 hours in duration. From an altitude of 40,000 feet, Ikhana's sensors were able to produce imagery that mapped the exact boundaries of the fire. Teams supporting the wildfire missions utilized on-board sensors to identify hotspots and collect other information that was then

Component Airmen, as determined by the Secretary of the Air Force.

**6. Staff Integration:** The Air Force should integrate the existing staffs of the Headquarters Air Force, the Air Force Reserve, and Air National Guard, similar to the principles recommended by the Total Force Task Force.

**7. AFR Unit Integration:** The Chief of Staff of the Air Force should direct the integration of Air Force Reserve associations of flights, squadrons, groups, and wings into corresponding Active Component organizations in order to eliminate the current redundant organizational overhead found in classic associations.

**8. Full-Time and Part-Time Mix:** The combination of full-time and part-time positions should be determined for each unit depending on weapon system requirements, deployment, and rotation schedule based on optimum matching of the needs of the Air Force, family, and employers. The unit should determine this composition in accordance with the mission assigned and in line with the full-time and part-time ratios represented by the current, independent, Active Air Force and Air Force Reserve units currently sharing missions.

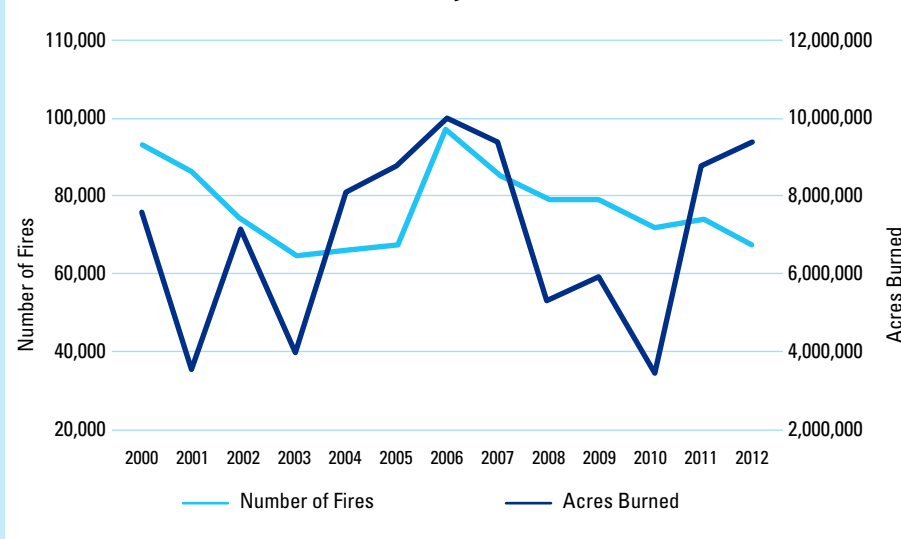
**9. ANG Unit Integration:** The Chief of Staff of the Air Force should direct the integration of Air Force flights, squadrons, groups, and wings into

corresponding Air National Guard organizations in order to eliminate the current redundant organizational overhead found in active associations.

**10. ANG Unit Size:** The Chief of Staff of the Air Force, in coordination with the Director of the Air National Guard, should change wing-level organizations to group organizations where the Airmen population and associated equipment are more realistically sized at the group level. The unnecessary recent growth of ANG wings from groups created excessive overhead positions that detract from availability to directly support training, peacetime, and wartime missions.

## REMOTELY PILOTED AIRCRAFT IN WILDFIRES

**U.S. Annual Wildfire Activity (2000–2012)**



provided fire commanders on the ground using Google Earth maps. With this integrated data, firefighters were able to map a complex strategy for fighting the fire.

Despite these benefits, significant challenges hinder RPA use in the United States. The FAA requires RPAs to follow the same guidelines as those of manned aircraft, including the

ability to “see and avoid,” which conventional pilots can do using peripheral vision; RPA pilots do not have that capability. RPAs similar to the Ikhana are testing automated collision avoidance technology to see if such systems can avoid contact with other vehicles in the air as well as on the ground.

In the meantime, RPAs are required to have a

Certificate of Waiver or Authorization, commonly known as a COA, in order to operate in the national airspace. These COAs contain information regarding the platform’s mission and emergency procedures if the pilot in command happens to lose contact with the aircraft. Natural disasters do not permit authorities the time to build and approve these waivers, so, in high-threat fire locations, COAs are processed for approval in advance.

A large percentage of RPA assets remain overseas. In Remote Split Operations, Air National Guard units perform the Mission Control Element (MCE) function at CONUS bases while the Launch and Recovery Element (LRE) serves close to the assigned mission area.

Civil and military authorities already coordinate through the Modular Airborne Fire-Fighting System (MAFFS) established in 1974. Operated by the Department of Defense, the Air National Guard, and the National Forest Service, a DoD-owned C-130 is configured to carry a Forest Service-owned 3,000-gallon aerial fluid dispersal system. RPAs could either mirror the MAFFS program or be folded into it, allowing the Guard to start operations more quickly. Alternately, the Forest Service could own RPA assets similar to MAFFS while the Air National Guard provides the MCE.



### 11. Concurrent Fielding of

**Equipment:** As the Air Force acquires new equipment, force integration plans should adhere to the principle of proportional and concurrent fielding across the components. This means that, in advance of full integration, new equipment will arrive at Air Reserve Component units simultaneously with its arrival at Active Component units in the proportional share of each component. As the Air Force Reserve and Active Component become fully integrated, the Air Force should ensure that the Air National Guard receives new technology concurrent with the integrated units. The Air Force should no longer recapitalize by cascading equipment from the Active Component to the Reserve Components.

**12. Policy Revisions:** Integrating units will require manpower and personnel policy revisions. The Air Force should modify AFI 90-1001 “Responsibilities for Total Force Integration” to establish selection and assignment criteria, the minimum proportion of leadership positions that must be filled by the associating components, and the methods to ensure compliance. The AF/A1 and Air Force Personnel Center should then reassign Airmen in disestablished Air Force Reserve units to integrated Title 10 units composed of Active Air Force, Reserve, full-time and part-time Airmen.

**13. DOC Statements:** The Air Force should discontinue the practice of separate designated operational capability (DOC) documents for Active and Reserve units of the same type and place the i-Units under single DOC statements. An initial i-Wing pilot program should be conducted at an associate wing that has already established a record of success.

**14. Key Leadership Positions:** The Air Force should ensure that integrated units are filled competitively by qualified Airmen irrespective of component, but key deputy positions (such as vice, deputy, subordinate echelon commander) should always be filled by an “opposite” component member.

**15. Effective Control Measures:** The Air Force must establish effective control measures to ensure that both Active and Air Reserve Component Airmen have adequate paths and opportunities for advancement and career development.

**16. Awards, Decorations, and Promotions:** The integrated chain of command must take special care in managing personnel issues such as awards and decorations, promotions, and assignment opportunities, both for those who seek to compete for increasingly higher levels of responsibility and for those who opt to sustain longevity in exercising and developing a particular skill set.

**17. Professional Military Education Positions:** Commander, Air University should develop a new baseline for its student and instructor positions to achieve a proportionate representation of the components on faculty and in the annual student body by FY 2018.

**18. Total Force Competency Standard:** Commander, Air Education and Training Command (AETC)

in coordination with the Assistant Secretary of the Air Force for Manpower and Reserve Affairs and AF/A1, should develop a Total Force competency standard for officers, non-commissioned officers, and enlisted Airmen across all specialties and career fields before the end of FY 2016. The AETC Commander should conduct a comprehensive curriculum review, similar to the one it completed for the Nuclear Enterprise in 2008–2009, to support professional and technical military education goals necessary for Airmen of all components to acquire cross-component skills, knowledge, comprehension, and analytic capability. The review should be completed by FY 2017, and the Chief of Staff of the Air Force should ensure a Total Force competency standard is implemented by FY 2018, such that it is available and resourced for all Airmen.

**19. Access to Non-Resident Education:** Commander, AETC should ensure that revised curriculum and competency standards are achievable by appropriately structured non-resident education programs equally accessible to personnel of all components. This must include special attention to the numerous ancillary training requirements that impose extraordinary burdens on traditional Air Reserve Component Airmen who must complete much of their training via distance learning but lack time and access to required information technologies to complete those training requirements in a timely manner while on drill status. A goal should be set to reduce unnecessary training requirements and to add flexibility to acceptable methods of completing those requirements that remain. ▶

*For additional detail refer to:*

Appendix J: Selected Statutes and Policies



“We have just won a war with a lot of heroes flying around in planes. The next war may be fought by airplanes with no men in them at all. It certainly will be fought with planes so far superior to those we have now that there will be no basis for comparison. Take everything you’ve learned about aviation in war, throw it out of the window, and let’s go to work on tomorrow’s aviation. It will be different from anything the world has ever seen.”

*Quote attributed to General Hap Arnold, U.S. Army Air Forces (USAAF), on VJ Day, 1945, in U.S. Air Force Global Vigilance, Global Reach, Global Power for America.*

## CHAPTER 4

# SIZING AND SHAPING THE FORCE

During hearings and visits to Air Force installations around the country, the Commission learned about the strengths and capabilities resident in all components of the Air Force. Air Force policies have ensured that all units and individuals of the Active Air Force, the Air National Guard, and the Air Force Reserve train to the same level of excellence and are thus equally ready to “fight tonight.”

Because all components are held to the same standard of readiness, the Air Force can maintain capacity and capability and reduce stress on the Active Component by maintaining or increasing the end strength of the Reserve Components and increasing regular, periodic, and predictable use of those forces. Prudent reductions in the Active Component will produce

meaningful cost-savings, mainly in military personnel accounts, and can reduce the need for cuts to readiness, modernization, and recapitalization.

Greater reliance on a larger Air Reserve Component provides a quickly “reversible” way to take manpower cost savings. (“Reversibility” is called for in the President’s 2012 “Priorities for 21st Century Defense,” where it is described as “the ability to regenerate capabilities that might be needed to meet future, unforeseen demands.”) It provides the ability to surge combat capability when needed. It provides additional return on investment of high-cost and high-value training received by Active Component Airmen. It maintains a link to states and communities throughout the nation in our unique form of federalism.

A force structure more reliant on a larger Air Reserve Component will not look exactly like the force the Air Force has successfully employed in recent decades. The Commission’s recommendation to make changes to that force is not a criticism of the preceding force structure; it is recognition that the future budgetary and security environments present new challenges that require new solutions. Sacrificing readiness to preserve force structure would create a hollow force. Instead, the Air Force can preserve readiness by shifting force structure from the Active to the Reserve Components.

### [End Strength Shift](#)

Every Air Reserve Component Airman that Commissioners spoke

with—from the most senior to the most junior—told of untapped potential in the Reserve Components. They conveyed that, over the past decades, the Reserve Components had provided only what they were asked to provide rather than the full limit of what they could provide. Commissioners tested these statements every way possible, recognizing that high self-confidence cannot always be accepted at face value. But this assertion was so unanimous and came from so many disparate sources that it could not be discounted.

The Commission estimated that it is feasible to shift the Air Force component mix from the current 69 percent Active and 31 percent Reserve to 58 percent Active and 42 percent Reserve. This would result in the shift of approximately 36,600 personnel and yield savings of perhaps \$2 billion per year in manpower costs with no reduction in Total Force end strength.

If this shift were proportionally allocated to the Air National Guard and the Air Force Reserve, the resultant increases would amount to 14,100 Airmen in the AFR and 22,500 in the ANG; nearly all would be part time.

To continue to meet the steady state mission requirement, this shift would require increased routine, periodic use of a portion of the Reserve Components serving on temporary active duty, either as volunteers or under the authority of 10 U.S.C. §12304b. This practice will be more cost effective than cuts limited to Active Component end strength because it allows for some reduction in the Active Component while also reducing stress on remaining Active Component forces, many of which have been operating at less than a 1:2 deploy-to-dwell ratio under the current force structure. Finally, such regular use of the Reserve Components will

help sustain its readiness and increase familiarity in the Active Component with Air Reserve Component operations, making Reserve and Guard units more useful when called to active duty in times of emergency.

**Re-Balance Missions**

Other solutions to emerging challenges involve employing the Air National Guard and Air Force Reserve in other mission areas to a greater extent than might once have been thought possible.

**Cyber**

In the Cyberspace Superiority core function, the Reserve Components provide about 11,000 Airmen representing 43 percent of total manpower for this mission—among the most integrated of the core functions. The Air Force has ambitious plans to expand its role in cyber operations and to increase the number

FIGURE 4: **Alternative Force Mix Calculation**

AFR	ANG	ARC		Active Duty Total	Total Force Total	
\$1,758,639.00	\$3,177,961.00	\$4,936,600.00		\$28,519,877.00	\$33,456,477.00	Military manpower cost of FY14 force mix (before additional cuts due to BCA/Sequestration)
70,494	105,400	175,894		332,056	507,950	Hypothetical additional end strength cuts due to further BCA/Sequestration reductions
		35%		65%		Military manpower cost after hypothetical cuts
		\$28.07	\$/Position	\$85.89	\$/Position	Alternate force mix to achieve same savings shift end strength from Active to Reserve Component)
3100	1700	4800	\$134,715.68	23000	\$1,975,441.40	
			135M Cut	309,056	\$1.98B Cut	
			27800	Positions Cut	\$2,110,157.09	
			(27,800)	New "Proportional" Air Force	\$31,346,319.91	Remaining Personnel \$\$\$
212,387	\$5,960,815.06	ARC		AD	332,056	295,563 (36,493) 58%
295,563	\$25,385,504.86	AD		ARC	175,894	212,387 36,493 42%
	\$31,346,319.91					

of Airmen in career fields associated with this emerging domain of war. Much of that increase should be met by the Reserve Components, which are well situated to recruit and retain from the specialized talent available in the commercial cyber labor market. The Air Force could apply to the cyber warfare domain its successful experience in the rated force, where the use of Reserve Component officers who are airline pilots creates a synergistic and positive effect. The commercial cyber world is at the leading edge of technology, and the Reserve Components would be able to recruit from that world, allowing the Air Force to benefit from a similar synergistic effect.

Research reported in May 2013 by the Institute for Defense Analyses (IDA Paper P-4986) found that the Air Force could perform this mission with higher value by using an integrated blend of Active and Air Reserve Component personnel and could lower total personnel costs by encouraging Reservists and Guardsmen to volunteer for service beyond the required 39 days. These findings were corroborated by testimony provided to the Commission by senior military and civilian officials from U.S. Cyber Command.

### Space and GIISR

Similar opportunities are available for expanded employment of Reserve Components in other growing mission areas, including Space and Global Integrated Intelligence, Surveillance, and Reconnaissance (GIISR.) The Air Force should build more Reserve Component opportunities in the space domain, especially in predictable continuity of operations missions and round-the-clock shift work. The Air Force should also build more Reserve Component opportunities in GIISR. In the high-deployment parts of Global ISR—such as RPA: MQ-1 Predator and MQ-9 Reaper launch and recovery teams—an increased Air Reserve

Component presence will mitigate some Active Component deployment stress. Likewise, and consistent with the Commission's recommendations in Chapter 3, these new units should be integrated with the Active Component, but the preponderance of new billets should be for Reservists and Guardsmen.

### Special Operations

Increased Reserve Component presence across the spectrum of Special Operations missions is also feasible and appropriate. The Commission found several unique opportunities already being filled by the Reserve Components, not only in some MC-130 flying squadrons, but also in the Building Partnerships core function.

The Air Force should increase Reserve Component presence in Special Operations through greater integration. This will mitigate some Active Component PERSTEMPO stress in the Special Operations community and foster an environment that retains skilled Airmen.

### Nuclear Deterrence Operations

Even Nuclear Deterrence Operations, where the Active Component dominates, has room for increased Reserve Component involvement. The 219th North Dakota Air National Guard Security Forces Squadron, in a classic association, already provides missile field security for the 91st Missile Wing at Minot Air Force Base, N.D., and serves as

## CYBER RANGE

The state of Michigan wants to stay on top of cyber security as a public welfare issue and a jobs-building core competency for the state, using cyber training and development in order to prepare future cyber leaders and warriors to serve the state and nation. The Michigan National Guard is integral to this effort.

One element of this strategy is the Cyber Range. Much like a traditional firing range, the Cyber Range is available for individuals and organizations to test their cyber security skills and take classes to improve them. The state established its first Cyber Range at Eastern Michigan University in Ypsilanti and plans to expand to Ferris State University in Big Rapids and the Michigan National Guard's 110th Airlift Wing in Battle Creek. The Range is connecting with Selfridge ANG Base and National Guard installations at Camp Grayling and Fort Custer.

Operating on the Merit Fiber Network out of Ann Arbor, Michigan's Cyber Range is available to students, researchers, businesses, institutions, and governments. Users can bring their cyber security systems to the Range where expert teams test them for vulnerabilities. Classes are available at three experience levels and include certifications for various levels of security expertise, disaster recovery, computer forensics, and incident management.

Michigan Governor Rick Snyder is the co-chair for the National Governors Association Cyber Committee and actively supports the National Guard Bureau Cyber Steering Committee. Michigan recently began holding an annual Cyber Summit, and The Adjutant General, MG Gregory J. Vadnais, was featured at the latest summit in October.

The 110th Communications Flight at Battle Creek is one of five cyber mission flights across the nation, along with a combat communications squadron, created in 2009 to undertake the new Guard Global Information Grid Net Assessment coverage for every Federal Emergency Management Agency region. The Guard units work with state governments and the defense industrial base to evaluate vulnerabilities of critical infrastructure and key resources.

an exemplar. The 219th is effective at maintaining nuclear certification and Personnel Reliability Program compliance. As a pilot program, the Air Force should expand Reserve Components' contributions to the ICBM mission by duplicating the 219th Security Forces Squadron model across all three ICBM wings. This should be done by the end of FY 2016. As lessons are learned, the Air Force should expand the SFS model to missile maintenance and helicopter functions between FY 2017 and FY 2019.

### Training

Considerable opportunity exists for cost-avoidance in the Training and

Education core function by shifting effort to the Reserve Components. We commissioned a cost analysis by the Institute for Defense Analysis (IDA) which reported that increased reliance on the Reserve Components to provide permanently assigned part-time instructor pilots offers a significant opportunity for cost-avoidance.

IDA found that most initial pilot training is currently provided by Active Component instructors. Active pilots assigned to instructor positions must be replaced in the operational force. Their replacements must (over the long run) be recruited, trained, and compensated. In addition, after a three-year instructor tour, these pilots

must go through a retraining program to allow them to return to operational billets. Some of the 1,800 Active instructor pilots could be replaced with prior-service volunteers from the Reserve Components who would not rotate back to operational squadrons, thus avoiding retraining costs. The result of IDA's analysis is that such an Active-to-Reserve force structure shift could potentially save \$1.3 million per instructor billet in the short run, as instructors are replaced over a three-to-five-year period, and \$2.8 million per instructor billet in the long run as unneeded facilities are closed.

### [A New Active-Reserve Component Mix](#)

The Commission found multiple paths to redistributing Active and Reserve Component personnel across core functions and Air Force specialties. For example, Space, GIISR, Special Operations, Nuclear Deterrence Operations, and Training mission areas could readily accommodate such shifts because the associated core functions are predominantly manned by the Active Component. Moreover, several other Air Force core functions, including Global Precision Attack, Rapid Global Mobility, and Agile Combat Support, already are accustomed to rotational operations into which Reserve Component units and individuals play a significant role. An example of such an alternative mix compared to the current mix for each core function is illustrated in Appendix K.

### [Homeland Defense and DSCA](#)

Homeland Defense and Defense Support to Civil Authorities (DSCA) are important missions for the Department of Defense. State Governors and other federal agencies rely on the Air Force to provide capabilities when natural and man-made disasters overwhelm local responders. The President's Strategic Guidance to

## DEFINITIONS

### **CAPABILITY**

The ability to maintain the necessary level and duration of operational activity to achieve military objectives. Entails force structure, modernization, readiness, and sustainability.

### **CAPACITY**

The force structure required to meet a single or multiple military objectives.

### **HOMELAND DEFENSE**

The protection of U.S. sovereignty, territory, domestic population, and critical infrastructure against external threats or aggression or other threats as identified by the President.

### **HOMELAND SECURITY**

A concerted national effort to prevent terrorist attacks within the United States; reduce America's vulnerability to terrorism, major disasters, and other emergencies; and minimize the damage and recover from attacks, major disasters, and other emergencies that occur.

### **DEFENSE SUPPORT TO CIVIL AUTHORITIES (DSCA)**

Support provided by the Department of Defense, including the National Guard and other U.S. federal military forces, in response to requests from civil authorities for assistance with domestic emergencies, law enforcement support, and other domestic activities, or from qualifying entities for special events. National Guard forces may be utilized when the Secretary of Defense in coordination with the Governors of the affected states, elects and requests to use those forces under Title 32 of the U.S. Code.



the Department of Defense specifies this mission as one of the 10 primary missions of the Armed Forces. For the DSCA mission, Governors need to know that when disasters

occur, sufficient federal capacity and capabilities will be available to support their needs.

Although both DoD and the Department of Homeland Security

(DHS) have processes to assess requirements for their respective responsibilities in addressing homeland contingencies, neither has fully developed, prioritized

## DUAL STATUS COMMANDER

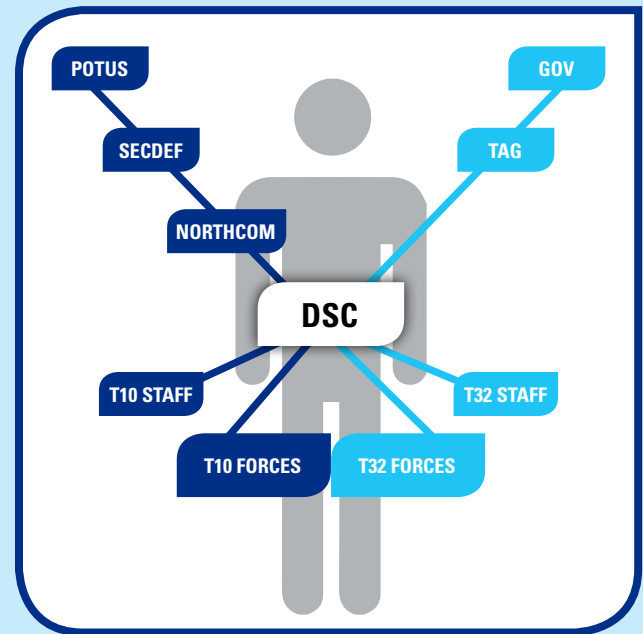
“DSC is a force multiplier to the Incident Command when clarity of unity of command is established early in the operation.”

Brig Gen Peter Byrne, Director, Joint Staff and Joint Task Force—Centennial Commander, Colorado Air National Guard, in correspondence to the National Commission on the Structure of the Air Force, Dec. 16, 2013.

**B**rig Gen Peter Byrne of the Colorado Air National Guard does not wear two hats; he wears a dual hat. As a dual status commander (DSC), he can be activated under Title 10—under the command of the President, Secretary of Defense, and NORTHCOM—but still remain in Title 32 status under the command of his Governor and The Adjutant General. This gives him legal authority to coordinate and command both Title 10 and Title 32 forces responding to an emergency in Colorado even though the lines of command above him and the forces below him remain separate.

Such dual status authority has been in existence since 1916, allowing Title 10 military personnel to occupy the role. However, it had never been used for a response to a no-notice event. After 9/11, political leaders recalibrated the doctrines of homeland defense, homeland security, and first response to allow better coordination among federal, state, and local authorities. With states concerned about ceding too much command and control authority to the federal government and the Posse Comitatus Act of 1878 prohibiting the federal military’s involvement in law enforcement, Congress amended Title 32 with the National Defense Authorization Act of Fiscal Year 2004 to give designated National Guard officers legal authority to serve as dual status commanders. A National Guard officer may now remain on state status while serving on active duty with the authorization and consent of the President and Governor.

With this new authority, dual status commanders were first used at national security special events, such as summit meetings, national political party conventions, and National Boy Scout Jamborees. In 2005 a dual status commander was used for the three-month northern border security operation, Winter Freeze. In the past few years, dual status commanders have been tapped to handle no-notice and consequence management responses such as the wildfires in California, Hurricane Irene (one each for five states), Hurricane Isaac (two), and Hurricane Sandy (six). The Fiscal Year 2012 NDAA also requires dual status commanders to be used as the “usual and customary” command arrangement when federal and National Guard forces are simultaneously employed. This command construct



could also be used in associated air wings combining Guard and Reserve or Active units.

The dual status commander is the single point of contact between the two chains of command. With two independent staffs, one Guard and one federal, the dual status commander must maintain completely separate commands of forces. Title 10 forces may only be used for Title 10 missions, and Title 32 may only be used for Title 32 missions. The only time their chains of command meet is in the dual status commander. But these chains do not cross, even with the dual status commander: the purpose of the position is not to consolidate commands but to foster coordination and promote unity of effort.

Brig Gen Byrne served as dual status commander for Colorado’s two major wildfires in 2012 and 2013 and for the 2013 flood. He said his biggest challenges were anticipating unmet needs while supporting the incident command and maintaining situational awareness on decisions made by other organizations supporting the incident command. Another challenge was the “effective command transition of DoD forces responding under Immediate Response Authority (DoDD 3025.18) into a joint task force...all the while maintaining effectiveness in the disaster area.”

Airmen of both federal and state components are eager to engage. The dual status commander’s mission is to help them engage more efficiently as separate but collaborative forces.

requirements set in place for foreseeable homeland missions or an agreed-upon process for working with states to assure homeland requirements are systematically generated and addressed. Without a better mechanism to capture the Governors' needs and other DSCA requirements, the Air Force and DoD risk building a force structure that does not adequately account for the DSCA mission.

Two initiatives are meant to address this shortfall. First, the National Guard Bureau has drafted, but not yet adopted, Chief of the National

Guard Bureau instructions regarding a Joint Capability Assessment and Development Process. This process is designed to provide DoD a better picture of the capabilities required by the states for the federalized and non-federalized Homeland Defense and DSCA missions. If fully integrated into the Department's planning processes, this effort could prove valuable.

Second, Executive Order 13528, issued Jan. 11, 2010, established a Council of Governors. The Council includes officials of other executive departments and agencies to provide

consultation and advice on matters involving the National Guard of the various states; homeland defense; civil support; synchronization and integration of state and federal military activities in the United States; and other matters of mutual interest pertaining to National Guard, Homeland Defense, and civil support activities. Although the Secretary of Defense designated the Assistant Secretary of Defense for Homeland Defense and America's Security Affairs (ASD HD/ASA) as the executive agent for the joint consultative process,

## HURRICANE SANDY

### DEFINITION

#### COMPLEX CATASTROPHE

The Department of Defense defines a complex catastrophe as a natural or man-made incident, including cyberspace attack, power grid failure, and terrorism, which results in cascading failures of multiple interdependent, critical, life-sustaining infrastructure sectors and causes extraordinary levels of mass casualties, damage, or disruption, severely affecting the population, environment, economy, public health, national morale, response efforts, or government functions.

"Sandy was not a complex catastrophe, but you could 'see' a complex catastrophe from Sandy."

General Charles H. Jacoby Jr.,  
Commander, North American  
Aerospace Defense Command and  
U.S. Northern Command, in DoD  
Sandy After-Action Report

When the Department of Defense practiced responding to a "complex catastrophe" in 2011, its scenario was a large earthquake that caused widespread property damage, critical infrastructure degradation across eight states, and "numerous casualties." On Oct. 29, 2012, Hurricane Sandy hit the mid-Atlantic and Northeast United States. The storm affected 29 states, left 8.5 million people without power, and knocked out 2,500 gas stations. Maryland saw 15.3 inches of rain; New York saw a 14-foot storm surge. At least 162 people were killed. Yet, Sandy did not qualify as a "complex catastrophe."

It was, nevertheless, historic, not only in its intensity and breadth but also in military annals as the first natural disaster in which the Fiscal Year 2012 National Defense Authorization Act Section 515 was applied: "When a Governor requests Federal assistance in responding to a major disaster or emergency ... the Secretary of Defense may, without consent of the member affected, order any unit, and any member not assigned to a unit organized to serve as a unit, of the Army Reserve, Navy Reserve, Marine Corps Reserve, and Air Force Reserve to active duty for a continuous period of not more than 120 days to respond to the Governor's request."

The first time testing such authority is likely to have hiccups, but confusion at the command and control (C2) level prompted the Government Accountability Office (GAO) to issue

a September 2013 study descriptively titled *Civil Support: Actions are Needed to Improve DoD's Planning for a Complex Catastrophe*. DoD concurred with the GAO's findings. Said a DoD and Department of Homeland Security Senior Steering Group after-action brief: "Effective senior leadership helped overcome these gaps, but in a true complex catastrophe, this will not be enough."

The federal military response to Sandy compared favorably to that of Hurricane Katrina in 2005. Newly legislated authorities governing dual status commanders and use of Title 10 forces in Title 32 missions removed many legal barriers that had hindered federal military forces participating in Katrina recovery as well as other major disasters. For Sandy, a total of 86 Air Force aircraft flew 284 sorties moving 640 personnel and 3,400 tons of cargo. Airlift conducted about 80 percent of missions, with 39 percent of sorties conducted by the Air Guard, 38 percent by Active, and 23 percent Reserve. One of the key missions was airlifting 241 public utility vehicles from western air bases to Joint Base McGuire-Dix-Lakehurst and John F. Kennedy International Airport.

Helpful as the military assistance was, operations were plagued by C2 issues. Tellingly, the AF/A9-Lessons Learned report says, "The Total Force response was largely a success because of Airmen's ingenuity, innovation, experience, and ability to modify or circumvent formal processes to over-

testimony to Commissioners indicated that progress in identifying and codifying holistic DSCA requirements has been slow.

The Air Force, particularly the Air National Guard and the Air Force Reserve, plays a significant role in both Homeland Defense and support of civil authorities. It can, and should, continue to do so; and, given the strategic environment and enhanced coordination with DHS, the Air Force will have opportunities in the future to increase its contribution to these missions. Communication between

state leaders and DoD can, and must, be improved, particularly in the area of disaster assistance.

Although no force structure decisions should be made exclusively based on disaster assistance requirements, the use of the Armed Forces to address emergencies at home is a core mission of all military branches, including the Air Force. Re-structuring to a Total Force more reliant on part-time mission support forces in the Reserve Components would provide more available capacity for DSCA and disaster assistance.

This especially would be the case in the instance of Agile Combat Support units that have dual-use opportunity, such as Civil Engineering, Security Forces, and Communications units, that have great value to their communities for disaster assistance.

The Commission recommends DoD and the Air Force treat Homeland Defense and DSCA as real priorities and Governors as essential stakeholders in planning processes. Doing so will enhance the Air Force's ability to contribute to the country's well-being without sacrificing the ability to deliver

## HURRICANE SANDY

come remaining organizational and doctrinal shortfalls." The primary entities involved were Army North (ARNORTH) as the joint force land component commander, and the dual status commanders (DSC) appointed by the Secretary of Defense for each heavily impacted state: Maryland, New Hampshire, New York, New Jersey, Massachusetts, and Rhode Island. Seeing a need for a C2 element between these dual status commanders and Northern Command, NORTHCOM created a joint coordinating element (JCE) in the days after Hurricane Sandy made landfall.

After-action reports mentioned the following C2 problems:

- The JCE's role, which was not based on doctrine, was neither well-defined nor well-communicated, thus contributing to the confusion.
- Title 10 personnel did not clearly understand the C2 structure for DSCs, the JCE, or high headquarters. They did not know which commander they were accountable to.
- DSC staff, reporting to two headquarters, had to de-conflict mixed guidance.
- On requests for DoD support, First Air Force (AFNORTH) senior leadership communicated directly with commercial entities and local government representatives rather than follow basic National Response Framework doctrine.



- Barriers to formal information sharing often compelled decision-makers to rely on personal relationships.

Matters of funding were also an issue. President Obama signed emergency declarations for Connecticut, the District of Columbia, Maryland, Massachusetts, New Jersey, and New York on the day before Sandy made landfall, and for Delaware, Pennsylvania, Rhode Island, Virginia, and West Virginia on the day of landfall. These triggered Stafford Disaster and Emergency Assistance Act authorities. The president afterward declared major disasters for Connecticut, New Jer-

sey, and New York. In testimony before this Commission, Todd M. Rosenblum, Principal Deputy Performing the Duties of the Assistant Secretary of Defense, said that the Secretary of Defense disapproved a request for Title 32, 502(f) resourcing forwarded him from the National Guard Bureau "because all support needs were already being met, and to have approved the request would have circumvented the Stafford Act process." Under the Stafford Act, FEMA pays 75 percent of response costs, localities pay 25 percent. Under Title 32 utilization, the Department of Defense would have covered 100 percent of the National Guard costs.





the air, space, and cyber power needed and expected in the “away game.”

The Commission’s recommendations to rebalance the Active and Reserve Components will accomplish a number of desirable goals:

- Enable significant monetary savings in Military Personnel Accounts without unreasonably increasing operational risk;
- Preserve funds for operational readiness and investment;
- Increase operational integration among components;
- Increase the number of opportunities for Airmen of all components to develop appreciation of each other’s capabilities by serving in integrated units;
- Increase the readiness of Air Reserve Component units and personnel by enabling them to utilize their military skills on a routine basis;
- Reduce installation maintenance burdens to better match the size of the current and projected Air Force;
- Enhance Air Force presence within American communities by preserving Air Reserve Component installations and basing more

personnel at those locations. This action will result in more Airmen and their families living in those communities.

#### ■ RECOMMENDATIONS

**20. Increase ARC Capacity:** The Air Force should increase its utilization of the Air Reserve Component by increasing the routine employment of ARC units and individuals to meet recurring rotational requirements. The measure of success in this increased use of the ARC should be the execution of at least 13,000 man years annually.

**21. Operational ARC Funding:** The Air Force should include in all future budget submissions a specific funding line for “operational support by the Air Reserve Component” to clearly identify and program those funds intended to permit routine, periodic employment of the ARC either as volunteers or under the authority of 10 U.S.C. §12304b.

**22. Council of Governors:** The Secretary of Defense should revise its agreement with the Council of Governors to enable Air Force leadership to consult directly with the Council of Governors when requested, including discussion of pre-decisional information.

**23. Non-Disclosure Agreements:** The Secretary of the Air Force should discontinue use of Non-Disclosure Agreements in the corporate process.

**24. State Adjutants General:** The Secretary of the Air Force should continue to advance current informal practice and mechanisms for engaging with The Adjutants General in development of the Air Force Program.

**25. Cyberspace Airmen:** As it increases the number of Airmen in career fields associated with

Cyberspace, the Air Force should fill much of that demand with the Reserve Components, which are well situated to recruit and retain from the specialized talent available in the commercial cyber labor market.

**26. Space Domain:** The Air Force should build more Air Reserve Component opportunities in the space domain, especially in predictable continuity of operations missions and round-the-clock shift work.

**27. GIISR Billets:** The Air Force should integrate all of its new Global Integrated Intelligence, Surveillance, and Reconnaissance units, and the preponderance of new billets should be for Reservists and Guardsmen.

**28. Special Operations:** The Air Force should increase Air Reserve Component presence in Special Operations through greater integration.

**29. ICBM Mission:** As a pilot program, the Air Force should, by the end of FY 2016, expand Air Reserve Component contributions to the ICBM mission by replicating the 219th Security Forces Squadron model across all three ICBM wings. As lessons are learned, the Air Force should expand the Security Forces model to Missile Maintenance functions between FY 2017 and FY 2019. The Air Force should also shift the Missile Field Helicopter mission to the Reserve Components.

**30. Instructor Pilots:** The Air Force should replace some of the 1,800 Active instructor pilots with prior-service volunteers from the Air Reserve Component who would not rotate back to operational squadrons.

**31. Homeland Security and Disaster Assistance:** The President should



direct the Departments of Defense and Homeland Security to develop, in full coordination with the Council of Governors, national requirements for Homeland Security and Disaster Assistance, both foreign and domestic.

**32. Homeland Defense and DSCA:** DoD and the Air Force should treat Homeland Defense and DSCA as real priorities and Governors as essential stakeholders in planning processes. ▶

*For additional detail refer to:*

Appendix J: Selected statutes and policies

Appendix K: Core function balance

Appendix O: Distinctions among homeland operations



“So here we find ourselves now at the end of another extended period of combat operations, a new military strategy. I think it’s time for us to take a hard look.”

*General (Ret.) Ronald R. Fogleman, former Chief of Staff, U.S. Air Force, in testimony before the National Commission on the Structure of the Air Force, July 23, 2013.*

## CHAPTER 5

# MANAGING THE FORCE

Innovation in force management processes to make better use of carefully selected and expensively trained Airmen is critical for the Air Force to sustain a high-quality work force in the midst of shrinking budgets and an increasingly competitive labor market. Effective force management policies enable quality recruitment, training, retaining, and utilization of the force. The Commission identified the following counterproductive human capital policies that currently undermine optimal employment of the Total Force.

### **Duty Statuses and Data Collection**

More than 30 different duty statuses govern activation and employment of Airmen. Because of the specific legal restrictions governing the allowable

## DEFINITIONS

### **DEPLOY-TO-DWELL**

Ratio of time Active Component military organizations spend deployed compared to the amount of time they spend not deployed. Thus, 1:2 means that for the period deployed the organization would spend two periods at home. (For Reserve Component forces, see Mobilization-to-Dwell.)

### **MOBILIZATION-TO-DWELL**

Ratio of time Reserve Component organizations or individuals spend mobilized for active duty compared to the amount of time they spend in a ready reserve state. Thus, 1:5 means that for each period mobilized the organization or individual would spend five periods at home.

### **PERSONNEL TEMPO (PERSTEMPO)**

The time an individual spends away from home station, whether for deployment, unit training events, special operations and exercises, or mission support temporary duty.



## “WHAT’S WITH THESE GUARD GUYS?”

*The following is an excerpt of a farewell address Lt Col Ryan Samuelson published prior to relinquishing command of the 64th Air Refueling Squadron at Pease ANG Base, N.H. The squadron is part of the 157th Air Refueling Wing, a Total Force Enterprise Active Associate Unit. Lt Col Samuelson is Active Air Force. The full address is part of a written comment submitted to the National Commission on the Structure of the Air Force by Major General William N. Reddel III, The Adjutant General of New Hampshire.*

“What’s with these Guard guys?!” This was a saying I heard many years ago in a land filled with sand: a time when I had never served side-by-side with someone from the Air National Guard; a time when the Total Force was beginning to serve overseas together more and more. The tone was derogatory, the question stated with antipathy. Maybe it was said in frustration or resentment; likely it was said out of ignorance born of unawareness and inexperience. At the time, I didn’t ponder it much, but here is what I wish I could have conveyed as a response: “Well, let me tell you what I have learned about ‘these Guard guys’—let me rephrase that: ‘Guard professional Airmen.’”

I have learned the Guard is about working in a collaborative environment, where ideas from all are shared both up and down the chain of command.

I have learned the Guard is about managing personnel who operate in a multitude of statuses while supporting more mission sets, both federal and state, than many Active units do. A single ANG aircrew compliment could be comprised of four personnel who all are governed by Title 10 rules overseas but each may operate under different statuses and management rules back home. I still haven’t figured out how they do it.

I have learned the Guard, through its development of the ANG Strategic Plan and Domestic Operations Equipment Requirements process, fully supports and greatly enhances the capabilities of the Total Force—not simply ANG efforts, and not simply a subset of Active Component plans.

I have learned the Guard is a learning organization, capable of achieving any task it is given. In standing up the Active Associate squadron here, the ANG, in partnership with the Active Component, solved complex issues—often with little clear written guidance from higher headquarters. In the absence of an approved Integration Plan, which was held up in staffing, the ANG established Memos of Understanding, internal policies, and previously untested processes. In the numerous instances where existing Air Force instructions used different criteria for Active Duty and ANG personnel, this wing found integrated answers to codify into a local operating instruction or process. In light of the fact we often operate in the “?” realm, our daily focus has always been to ensure we were meeting Chief of Staff of the Air Force’s direction to fully integrate Active personnel into the structure of our host wing in order to best serve the Combatant Commanders’ needs.

I have learned the Guard provides roughly 33 percent of the Air Force’s capability at 7 percent of the budget with a force that is 70 percent traditional. The ANG is structured, budgeted, and funded as a strategic reserve yet operates as a fully viable operational force—and a busy one at that.

I have learned the Guard is proud of its culture—and should be. It is a culture where people blend friendship and camaraderie perfectly with a burning desire to rapidly respond to any mission, state or federal.

I have learned the Guard is about taking care of the people who make up the organization, the families, the communities, and the country.

I do hope the education and understanding of both Active Duty and ANG patriots continue as we serve together in the coming years of fiscal challenges. The Guard has taught me so much. It is an organization I have come to know and immensely respect. I’m glad we’re on the same team.

duties within a specific status, each status has its own data categories and collection processes. This unnecessary and costly bureaucracy is a source of frustration among Airmen and stands in the way of recruiting, accession, and retention for the Reserve Components.

For example, aircrew members from different components flying a strategic airlift mission together will each log operational and training hours, but they will log them differently. Regulations might allow the Active Component Airmen to log both operational and training hours while the Reserve Component Airmen may only log training hours. When management later aggregates the data, the Reserve Component Airmen does not have the operational contribution credited to his or her service records, and the Air Force has an inaccurate picture of what type of mission each aircrew member flew.

The Under Secretary of Defense for Personnel and Readiness (USD(P&R)) has recently revised deploy-to-dwell and mobilization-to-dwell policy to characterize and manage the employment of the Total Force in order to preclude the overexposure of personnel to combat and operational deployments. The guidance affirms the deploy-to-dwell ratio for the Active Component is set at 1:2 or greater, and the mobilization-to-dwell ratio for the Reserve Components is 1:5 or greater. The Commission learned much regarding the workload and Personnel Tempo (PERSTEMPO) associated with alert missions, employed-in-place missions (such as Space and ICBM), high-demand missions, airlift, and combat search and rescue, and traditional rotations such as bomber and tanker presence on overseas bases.

The Air Force strives for compliance with USD(P&R) guidance, but the ratios specified in this guidance are less useful to the Air Force, which



has different deployment processes compared to those of land and naval forces. The Air Force often deploys not only in classical units like wings or squadrons, but also in portions of such units, down to the deployment of one or two Airmen. Some elements of the unit may have deployed while others have not, and other elements may have “deployed” by increasing time spent at home station facilities that directly support forward-deployed units. Thus, the deployment-to-dwell ratio of a unit is both difficult to measure and difficult to associate with how hard a unit or Airman is working, how much stress has been placed on the unit’s families, or what contribution the unit or Airman has made to the war fight.

The Air Force currently does not have a method of applying these ratios across the force; attempts to use these ratios provide inconsistent and sometimes misleading information about the rate at which the components and their members deploy. The Commission found that MAJCOMs use greatly varied processes for accounting deploy-to-dwell. In some cases, the accounting skewed the numbers to support an end state not supported by the facts. In other cases, the methodology did not adequately measure the two primary forms of stress on the force and families: the length of time an Airman is deployed in a period of time and the unpredictability of assigned missions, whatever their length.

Clearly, whenever an Airman is tasked to support a Combatant Commander—from alerts and high-velocity special operations and mobility missions to what has become traditional 180-day deployments and Theater Security Packages—the Airman is engaged in a mission, even if it is not a mission that takes the Airman away from home. A single metric, such as PERSTEMPO, is necessary

to measure accurately and uniformly the contribution and sacrifice across all mission types and components. However, in the DoD Instruction 1336.07, *Reporting of Personnel Tempo (PERSTEMPO) Events*, the guidelines for a non-deployed PERSTEMPO event for the Reserve Components limit the definition of active duty to those events that render the activated Reservist or Guardsman unable “to spend off-duty time in the housing in that (sic) they reside.” This limitation fails to account for the disruption to an Air Reserve Component member’s civilian job or attending school.

The Air Force needs a common approach across all components that measures stress on the force and that will respectfully measure and account for every Airman’s contributions. It is critical to serving Airmen that the Air Force values their service; this validation is just as critical to the family members, and, for members of the Reserve Components, their employers. If, as the Commission recommends, the Air Force would routinely and periodically employ the Reserve Components as an integrated part of an operational force, then the Air Force must develop metrics that accurately measure the impact of their military service.

Capturing the data necessary to understand the important human capital issues is challenging. In large part, the lack of data derives from the multiplicity of duty statuses and authoritative metrics. This lack of data does not reflect an unwillingness of agencies to share the data; rather, the existing data is incomplete, incorrect, or nonexistent. Moreover, the personnel systems and associated information technologies are not up to the complexities of force management under these conditions.

### Stove-piped Personnel Systems

Additional inefficiencies stem from the three separate personnel systems, each with its own information technology and administrative bureaucracy. Disparate personnel policies and pay systems make communication among the components difficult and result in significant inaccuracies in crediting Air Reserve Component Airmen for their service. These errors undermine Air Force decision-making by presenting leadership with inaccurate information when they are crafting policy changes that subsequently drive time-consuming and expensive corrections. Improved data integration technologies will mitigate part of this problem, but

## DEFINITIONS

### **ACTIVE DUTY**

Full-time duty in the active military service, including members of the Reserve Component serving on active duty or full-time training duty (but not including full-time National Guard duty serving the state).

### **CONTINUUM OF SERVICE**

A concept that removes or mitigates legal, procedural, and cultural barriers for personnel to transition among different components over the course of a career without derailing their professional advancement while also maximizing the service’s investment in that individual.

to truly integrate the Total Force, the Air Force must manage the personnel systems holistically as one Total Force system.

The Commission commends the Air Force for recognizing this shortfall and for its ambitious “3 to 1” Initiative. However, “3 to 1” Total Force Human Resources Management, though designated as the “new normal” way of doing business, lacks a definitive implementation date. Also, it stops short of integrating human capital management across the components. Illustratively, the first Air Force Instruction for Total Force Human Resources Management consists of different volumes for each component instead of one Air Force-wide instruction.

The Air Force has identified some

of these problems and proposed a new enabling system. It should improve tracking of different statuses in accordance with the different purposes of law as well as support proposals to reduce the number of legal statutes and authorities. Unfortunately, the Air Force does not expect the Air Force Integrated Personnel and Pay System (AF-IPPPS) to become operational until FY 2018. Airmen cannot wait that long.

#### Continuum of Service

Continuum of Service is an important enabler of many of the Commission’s recommendations regarding increased integration and holistic management of the Air Force’s components. Continuum of Service presumes the ability of an Airman to

transition more seamlessly among the three components. Historically, the characterization of transition from the Active Component to the Reserve Components has been “separation.” In public forums, Commissioners heard of Airmen who transferred from the Active Component to the Reserve Components being called “quitters,” even if they stepped back into uniform the next day and continued to support the overall mission of the Total Force.

While service in the Air Reserve Component is increasingly extolled by Air Force senior leaders who state RC members are equal to their Active counterparts in training, readiness, and performance, there is room for improvement throughout the Air Force culture. The Air Force must embrace the idea that service in the Reserve

## TANKER AIRLIFT CONTROL CENTER

Kurt Peterson was managing a Harley Davidson Dealership in Jonesboro, Ark., on Sept. 11, 2001, when one of his salesmen said something was happening on the TV. “After seeing that an airplane had hit the Towers, I said ‘I have to leave’ and drove to Scott Air Force Base,” Col (Ret.) Peterson said. “I immediately started working the tanker desk, supporting Air Force missions.” Col Peterson served at the Tanker Airlift Control Center (TACC) from its activation in 1992 until he retired from the Air Force Reserve in 2009 as the Reserve Advisor to the TACC Commander.

Every three minutes, somewhere around the globe, an Air Force cargo hauler (C-5 Galaxy, C-17 Globemaster III, or C-130 Hercules) or aerial refueler (KC-10 Extender or KC-135 Stratotanker) is scheduled to take off on a sortie. The scheduling and direction of this fleet of 1,300 aircraft is the responsibility of the 618th Air and Space Operations Center, also known as the TACC.

TACC manages an average of 470 point-to-point flights every day in support of Air Mobility Command (AMC) operations, including airlift, air refueling, aeromedical evacuation, and combat airdrops. Many of those missions support Operation Enduring Freedom, delivering food, equipment, and other supplies to U.S. and coalition troops. TACC also provides command and control oversight for humanitarian missions overseas and at home.

And on occasion, TACC must juggle three surges in three different theaters of operations at one time, as occurred in March 2011 in what Air



Force officials called “March Madness”: a 9.0 earthquake and tsunami in Japan, air strikes against Libya, and a Presidential airlift for President Barack Obama’s trip to South America, all on top of ongoing operations that included a surge of forces in Afghanistan and a draw-down—and transportation home—of troops in Iraq.

Within the first 24 hours of the disaster in Japan, three C-17 missions launched in support of Operation Tomodachi (“friend”) as the United States started shipping 2 million gallons of water, 189 tons of food, 11,960 gallons of fuel, and 100 tons of relief supplies. Because of the significant damage from the tsunami, U.S. forces coordinated support in and out of Japan through a hub-and-spoke concept, with the TACC flowing major cargo movements into U.S. installations and outlying areas of Japan and Okinawa and then transporting supplies to the

Components does not constitute “separation” or “getting out of the Air Force,” but rather is a way for Airmen to continue to serve and for the nation to maintain capability and preserve its investment in highly trained and dedicated people.

The first step toward Continuum of Service is to make affiliation to the Reserve Components not just attractive, but an expected norm for Airmen who choose to leave full-time active duty. Current practices regarding pilot retention bonuses are illustrative. The Air Force offers Active Component pilots retention bonuses of hundreds of thousands of dollars to remain in the Active Component for an additional term of years. That same pilot is offered no affiliation bonus to transfer to the Reserve Components,

and no pilot bonus is available for traditional Reservists who extend their service. Only Active Component and Active Guard and Reserve (AGR) pilots are eligible for the bonus, despite the well-recognized and acknowledged equity in training and readiness among all members of the Total Force. Given the multi-million-dollar investment to train each pilot, a substantial incentive to affiliate with the Reserve Components is a wise investment. Such an incentive should include the availability of a proportional bonus for traditional Reserve members based on the days they actually serve. A similar approach needs to be taken for other career fields (e.g., cryptology or cyber), where extensive, expensive training is required to build a fully mature Airman.

Another important purpose of Continuum of Service is to offer Airmen more on- and off-ramps for life events, such as pregnancy, spouse career opportunity, enduring family medical issues, and education. This concept is not new: but in the past the continuum has flowed only toward the Reserve Components because a combination of law and tradition has made it exceptionally difficult for Airmen to return to Active Component service. A proper Continuum of Service approach would allow members to transition to a part-time Reserve Component position with the potential to return to the Active Component when circumstances change. This concept also applies to moving freely between the Air Force Reserve and the Air National Guard to accommodate Air

## TANKER AIRLIFT CONTROL CENTER

disaster-affected areas with helicopters and smaller fixed-wing aircraft. Additionally, the U.S. government evacuated nearly 5,000 U.S. citizens, primarily using partner programs with civilian air carriers. All told, AMC aircraft flew 127 sorties, carried 6,213 passengers, and transported 816 tons of cargo in support of Operation Tomodachi.

Seven days after the crippling Japanese earthquake, Operation Odyssey Dawn began with President Obama’s announcement that the U.S. military would support NATO and Arab League allies enforcing the United Nations Security Council Resolution 1973 establishing the no-fly zone in Libya. In a matter of hours, the 171st Air Refueling Wing, Pennsylvania Air National Guard, mobilized and deployed to Moron Air Base in Spain. In less than 24 hours, the 171st ARW sent 40 tons of cargo and more than 160 personnel to support Operation Odyssey Dawn. Over the next 48 hours, KC-135 and KC-10 tankers from 10 Air National Guard and Air Force Reserve Command air refueling wings would be sitting on the ramp in Moron. Eventually 20 different bases would provide tankers and personnel in support of Odyssey Dawn and the subsequent Operation Unified Protector.

For both Libya operations, TACC managed missions flying from Moron AB and NAS Rota in Spain, RAF Akrotiri in Cyprus, NAS Sigonella in Italy, and NAS Souda Bay in Greece. In the 13 days of Operation Odyssey Dawn, the United States flew 876 of the Coalition’s 2,132 aircraft sorties, tallying approximately 9,418 of the total 13,930 hours flown. U.S. tanker aircraft flew 311 missions offloading more than 17.3

million pounds of fuel. U.S. airlift aircraft flew 151 missions transporting 3,177 passengers and 2,372 short tons of cargo.

TACC’s pace indicates the impact simultaneous requirements for Operation Enduring Freedom, Operation New Dawn, Operation Unified Protector, and Operation Tomodachi had on AMC. From January to March 2011, TACC managed a 60 percent increase in C-5 utilization and a 26 percent increase for C-17s. AMC also maximized its KC-10 and KC-135 fleet, which flew 1,706 missions and offloaded 57.8 million pounds of fuel.

Even at a normal steady-state pace, the amount of global movement requires TACC staff to operate 24 hours a day and emphasizes the need for experience. Approximately 20 percent of the center’s 700 personnel are members of the Air National Guard and Air Force Reserve, including Individual Mobilization Augementees assigned to TACC and personnel on Military Appropriation Orders assigned to other commands.

Prior to September 2001, a limited number of Reserve Component members worked in the 618th; their presence and role have increased dramatically since. “The experience that Guardsmen and Reservists bring to the table is invaluable,” Col Peterson said. They create continuity for the organization, he said, and often the Guard and Reserve personnel demonstrate practices or procedures to Active Component members new to TACC.





Reserve Component members who move to a different geographic area.

A further personnel change that would facilitate Continuum of Service is lengthening the officer career trajectory. Lengthening of that trajectory for selected Airmen would benefit the Air Force by allowing it to retain its highly skilled workforce for a longer time. Current law and policy, including Defense Officer Personnel Management Act and Reserve Officer Personnel Management Act provisions that mandate high-year tenure and an “up-or-out” personnel policy, cause

the Air Force to apply a one-size-fits-all method of career development. Providing additional flexibility to selected Airmen in both the Reserve Components and the Active Component in terms of their career goals and the length of their service would result in less churn and greater time in service for highly trained Airmen. This will, in turn, allow the service to realize substantial savings in recruiting, training, and development costs. The “up-or-out pyramid” that arbitrarily eliminates highly qualified people while the Air Force still needs

them and before they are ready to stop serving is a poor approach to talent management.

#### ■ RECOMMENDATIONS

**33. Duty Statuses:** Congress should reduce the number of separate duty statuses from more than 30 to no more than six, as has been recommended by the Quadrennial Review of Military Compensation and, more recently, by the Reserve Forces Policy Board. Reducing the number of duty status categories will make it easier for Air Reserve Component Airmen to serve in an operational capacity. The Air Force can implement this change in a way that does not diminish the overall compensation of Air Reserve Component members. Numerous provisions in current law that may require change are identified in Appendix J.

#### **34. Integrated Personnel**

**Management:** The Air Force should unify personnel management for all three components under a single integrated organization (A1) in the Headquarters Air Staff. This is a different concept than an office that would oversee and integrate the activities of three separate component A1s. The Air Force should aggressively implement the “3 to 1” process but widen and amplify the effort to include integration of the three components’ personnel management processes for such matter as recruiting, assignments, force development, and force management. A unified personnel management organization could best manage the portfolio of Air Force Specialty Codes and achieve the most favorable utilization rates, retention rates, and human capital cost controls.

#### **35. Integrated Pay and Personnel**

**System:** The Air Force should accelerate the development of an Integrated Pay and Personnel System



(AF-IPPS). The goal should be completion not later than 2016. The Air Force should ensure that this single system is capable of properly producing orders as well as accounting for and paying Airmen from all three components with a focus on providing a clear, simple structure under which the Air Force calls Air Reserve Component members to serve. This will result in an increased ability to plan, program for, and gain access to Air Reserve Component Airmen for any training and operational purposes. It will provide the means to capture the legal purpose and method of reimbursement of the Reserve Components for tracking and analyzing data.

**36. PERSTEMPO Metric:** The Air Force should use a single metric for measuring the personnel tempo and stress on its forces, both Active and Reserve. The Commission also recommends that the Air Force utilize this “PERSTEMPO, stress on the force” metric to determine sustainable levels of employment for the Active

Component, and for the Reserve Components when partial mobilization authority is not used.

**37. Non-Deployment**

**PERSTEMPO:** USD(P&R) should update the definition of a non-deployment PERSTEMPO event for the Reserve Components to include those situations where placement on active duty orders under either Title 10 or Title 32 causes the Air Reserve Component member to be away from his or her civilian job or attendance at school.

**38. PERSTEMPO and AF-IPPS:**

The Air Force should include PERSTEMPO accounting in AF-IPPS.

**39. Continuum of Service:** The Total Force Continuum should develop and supervise implementation of a pilot project for the implementation of Continuum of Service to commence by Oct. 1, 2014.

**40. Active Duty Service**

**Commitments:** The Air Force should

revise the rules for current Active Duty Service Commitments to enable members to meet the commitment in some combination of Active, Reserve, and Guard service.

**41. Multiple Career Track Options:**

The Air Force should develop a new service construct consisting of multiple career track options, each with different high-year tenure controls, where such additional tenure serves the needs of the Air Force. At a minimum, the following career tracks require study: tactical or technical excellence and enterprise leadership.

**42. “Up or Out”:** Congress should amend restrictive aspects of current statutes that mandate “up-or-out” career management policies to enable the Air Force to retain Airmen of all components actively working in career fields where substantial investment in training and career development has been made and where it serves the needs of the Air Force. ▶



## APPENDIX A

# ESTABLISHMENT OF COMMISSION

### **National Defense Authorization Act for Fiscal Year 2013 (Public Law 112–239, —Jan. 2, 2013),**

### **Subtitle G—National Commission on the Structure of the Air Force**

#### **SEC. 361. SHORT TITLE.**

This subtitle may be cited as the “National Commission on the Structure of the Air Force Act of 2012.”

#### **SEC. 362. ESTABLISHMENT OF COMMISSION.**

(a) **ESTABLISHMENT.**—There is established the National Commission on the Structure of the Air Force (in this subtitle referred to as the “Commission”).

(b) **MEMBERSHIP—**

(1) **COMPOSITION.**—The Commission shall be composed of eight members, of whom—

(A) four shall be appointed by the President;

(B) one shall be appointed by the Chairman of the Committee on Armed Services of the Senate;

(C) one shall be appointed by the Ranking Member of the Committee on Armed Services of the Senate;

(D) one shall be appointed by the Chairman of the Committee on Armed Services of the House of

Representatives; and

(E) one shall be appointed by the Ranking Member of the Committee on Armed Services of the House of

Representatives.

(2) **APPOINTMENT DATE.**—The appointments of the members of the Commission shall be made not later than 90 days after the date of the enactment of this Act.

(3) **EFFECT OF LACK OF APPOINTMENT BY APPOINTMENT DATE.**—If one or more appointments under subparagraph (A) of paragraph (1) is not made by the appointment date specified in paragraph (2), the authority to make such appointment or appointments shall expire, and the number of members of the Commission shall be reduced by the number equal to the number of appointments so not made. If an appointment under subparagraph (B), (C), (D), or (E) of paragraph (1) is not made by the appointment date specified in paragraph (2), the authority to make an appointment under such subparagraph shall expire, and the number of members of the Commission shall be reduced by the number equal to the number otherwise appointable under such subparagraph.

(4) **EXPERTISE.**—In making appointments under this subsection, consideration should be given to individuals with expertise in reserve forces policy.

(c) **PERIOD OF APPOINTMENT; VACANCIES.**—Members shall be appointed for the life of the Commission. Any vacancy in the Commission shall not affect its powers, but shall be filled in the same manner as the original appointment.

(d) **INITIAL MEETING.**—Not later than 30 days after the date on which all members of the Commission have been appointed, the Commission shall hold its first meeting.

(e) **MEETINGS.**—The Commission shall meet at the call of the Chair.

(f) **QUORUM.**—A majority of the members of the Commission shall constitute a quorum, but a lesser number of members may hold hearings.

(g) **CHAIR AND VICE CHAIRMAN.**—The Commission shall select a Chair and Vice Chair from among its members.

**SEC. 363. DUTIES OF THE COMMISSION.****(a) STUDY.—**

(1) **In General.**—The Commission shall undertake a comprehensive study of the structure of the Air Force to determine whether, and how, the structure should be modified to best fulfill current and anticipated mission requirements for the Air Force in a manner consistent with available resources.

(2) **CONSIDERATIONS.**—In considering the structure of the Air Force, the Commission shall give particular consideration to evaluating a structure that—

(A) meets current and anticipated requirements of the combatant commands;

(B) achieves an appropriate balance between the regular and reserve components of the Air Force, taking advantage of the unique strengths and capabilities of each;

(C) ensures that the regular and reserve components of the Air Force have the capacity needed to support current and anticipated homeland defense and disaster assistance missions in the United States;

(D) provides for sufficient numbers of regular members of the Air Force to provide a base of trained personnel from which the personnel of the reserve components of the Air Force could be recruited;

(E) maintains a peacetime rotation force to support operational tempo goals of 1:2 for regular members of the Air Forces and 1:5 for members of the reserve components of the Air Force; and

(F) maximizes and appropriately balances affordability, efficiency, effectiveness, capability, and readiness.

**(b) REPORT.**—Not later than February 1, 2014, the Commission shall submit to the President and the congressional defense committees a report which shall contain a detailed statement of the findings and conclusions of the Commission as a result of the study required by subsection (a), together with its recommendations for such legislation and administrative actions it may consider appropriate in light of the results of the study.

**SEC. 364. POWERS OF THE COMMISSION.**

**(a) HEARINGS.**—The Commission may hold such hearings, sit and act at such times and places, take such testimony, and receive such evidence as the Commission considers advisable to carry out this subtitle.

**(b) INFORMATION FROM FEDERAL AGENCIES.**—The Commission may secure directly from any Federal department or agency such information as the Commission considers necessary to carry out this subtitle. Upon request of the Chair of the Commission, the head of such department or agency shall furnish such information to the Commission.

**(c) POSTAL SERVICES.**—The Commission may use the United States mails in the same manner and under the same conditions as other departments and agencies of the Federal Government.

**(d) GIFTS.**—The Commission may accept, use, and dispose of gifts or donations of services or property.



**SEC. 365. COMMISSION PERSONNEL MATTERS.**

(a) **COMPENSATION OF MEMBERS.**—Each member of the Commission who is not an officer or employee of the Federal Government shall be compensated at a rate equal to the daily equivalent of the annual rate of basic pay prescribed for level IV of the Executive Schedule under section 5315 of title 5, United States Code, for each day (including travel time) during which such member is engaged in the performance of the duties of the Commission. All members of the Commission who are officers or employees of the United States shall serve without compensation in addition to that received for their services as officers or employees of the United States.

(b) **TRAVEL EXPENSES.**—The members of the Commission shall be allowed travel expenses, including per diem in lieu of subsistence, at rates authorized for employees of agencies under subchapter I of chapter 57 of title 5, United States Code, while away from their homes or regular places of business in the performance of services for the Commission.

(c) **STAFF**—

(1) **IN GENERAL.**—The Chair of the Commission may, without regard to the civil service laws and regulations, appoint and terminate an executive director and such other additional personnel as may be necessary to enable the Commission to perform its duties. The employment of an executive director shall be subject to confirmation by the Commission.

(2) **COMPENSATION.**—The Chair of the Commission may fix the compensation of the executive director and other personnel without regard to chapter 51 and subchapter III of chapter 53 of title 5, United States Code, relating to classification of positions and General Schedule pay rates, except that the rate of pay for the executive director and other personnel may not exceed the rate payable for level V of the Executive Schedule under section 5316 of such title.

(d) **DETAIL OF GOVERNMENT EMPLOYEES.**—Any Federal Government employee may be detailed to the Commission without reimbursement, and such detail shall be without interruption or loss of civil service status or privilege.

(e) **PROCUREMENT OF TEMPORARY AND INTERMITTENT SERVICES.**—The Chair of the Commission may procure temporary and intermittent services under section 3109(b) of title 5, United States Code, at rates for individuals which do not exceed the daily equivalent of the annual rate of basic pay prescribed for level V of the Executive Schedule under section 5316 of such title.

**SEC. 366. TERMINATION OF THE COMMISSION.**

The Commission shall terminate 90 days after the date on which the Commission submits its report under section 363.

**SEC. 367. FUNDING.**

Amounts authorized to be appropriated for fiscal year 2013 and available for operation and maintenance for the Air Force as specified in the funding table in section 4301 may be available for the activities of the Commission under this subtitle.

*Source: Government Printing Office, [www.gpo.gov/fdsys/pkg/PLAW-112publ239/pdf/PLAW-112publ239.pdf](http://www.gpo.gov/fdsys/pkg/PLAW-112publ239/pdf/PLAW-112publ239.pdf).*

## APPENDIX B

# RECOMMENDATIONS

- 1—Cost Approach:** DoD should formally adopt the “fully burdened cost” approach to calculating military personnel costs, and it should apply analytic methods that focus on appropriate outputs along with life-cycle costs. The Department should then modify DoD Instruction 7041.04 to establish a common list of the various elements of pay, benefits, and other costs that contribute to the “fully burdened” or “life cycle” cost that all services would then use in calculating the cost of personnel. This will enable the Air Force to assess accurately force structure issues and choices in terms of fully burdened, total life-cycle costs of human capital, as well as operating costs of units and aircraft. [Chapter 2]
- 2—Budgeting Flexibility:** In the Fiscal Year (FY) 2015 National Defense Authorization Act and Defense Appropriations Act, Congress should allow DoD increased flexibility in applying budget cuts across budget categories, including installations. [Chapter 2]
- 3—Resourcing the Reserve Components:** To ensure the Air Force leverages full capacity of all components of the force, in its FY 2016 Program Objective Memorandum, the Air Force should plan, program, and budget for increased reliance on the Reserve Components. The Commission recommends: (1) the Air Force should include in all future budget submissions a specific funding line for “operational support by the Air Reserve Component” to clearly identify those funds programmed for routine periodic employment of the ARC either as volunteers or under the authority of 10 U.S.C. §12304b; (2) in its future budget submissions the Air Force should program for approximately 15,000 man years of operational support annually by the Air Reserve Component; (3) in succeeding years, the Air Force should monitor the execution of this program element to ensure it is utilizing the Air Reserve Component to its fullest extent. [Chapter 2]
- 4—Infrastructure:** The Air Force should consider, and Congress should allow, the closing or warm basing of some installations. [Chapter 2]
- 5—Air Force Reserve Command:** Congress should amend 10 U.S.C. §10174 to retain the statutory rank, roles, responsibilities, and functions of the Director, Air National Guard, and Chief of the Air Force Reserve but disestablish the Air Force Reserve Command. The Air Force should inactivate the Reserve Numbered Air Forces, wings, and squadrons. The roles, responsibilities, and functions of disestablished organizations should be assumed by the Secretary of the Air Force, Headquarters Air Force, and MAJCOMS, all of which will have increased representation by Air Reserve Component Airmen, as determined by the Secretary of the Air Force. [Chapter 3]
- 6—Staff Integration:** The Air Force should integrate the existing staffs of the Headquarters Air Force, the Air Force Reserve, and Air National Guard, similar to the principles recommended by the Total Force Task Force. [Chapter 3]
- 7—AFR Unit Integration:** The Chief of Staff of the Air Force should direct the integration of Air Force Reserve associations of flights, squadrons, groups, and wings into corresponding Active Component organizations in order to eliminate the current redundant organizational overhead found in classic associations. [Chapter 3]
- 8—Full-Time and Part-Time Mix:** The combination of full-time and part-time positions should be determined for each unit depending on weapon system requirements, deployment, and rotation schedule based on optimum matching of the needs of the Air Force, family, and employers. The unit should determine this composition in accordance with the mission assigned and in line with the full-time and part-time ratios represented by the current, independent, Active Air Force and Air Force Reserve units currently sharing missions. [Chapter 3]
- 9—ANG Unit Integration:** The Chief of Staff of the Air Force should direct the integration of Air Force flights, squadrons, groups, and wings into corresponding Air National Guard organizations in order to eliminate the current redundant organizational overhead found in active associations. [Chapter 3]
- 10—ANG Unit Size:** The Chief of Staff of the Air Force, in coordination with the Director of the Air National Guard, should change wing-level organizations to

group organizations where the Airmen population and associated equipment are more realistically sized at the group level. The unnecessary recent growth of ANG wings from groups created excessive overhead positions that detract from availability to directly support training, peacetime, and wartime missions. [Chapter 3]

- 11—Concurrent Fielding of Equipment:** As the Air Force acquires new equipment, force integration plans should adhere to the principle of proportional and concurrent fielding across the components. This means that, in advance of full integration, new equipment will arrive at Air Reserve Component units simultaneously with its arrival at Active Component units in the proportional share of each component. As the Air Force Reserve and Active Component become fully integrated, the Air Force should ensure that the Air National Guard receives new technology concurrent with the integrated units. The Air Force should no longer recapitalize by cascading equipment from the Active Component to the Reserve Components. [Chapter 3]
- 12—Policy Revisions:** Integrating units will require manpower and personnel policy revisions. The Air Force should modify AFI 90-1001 “Responsibilities for Total Force Integration” to establish selection and assignment criteria, the minimum proportion of leadership positions that must be filled by the associating components, and the methods to ensure compliance. The AF/A1 and Air Force Personnel Center should then reassign Airmen in disestablished Air Force Reserve units to integrated Title 10 units composed of Active Air Force, Reserve, full-time and part-time Airmen. [Chapter 3]
- 13—DOC Statements:** The Air Force should discontinue the practice of separate designated operational capability (DOC) documents for Active and Reserve units of the same type and place the i-Units under single DOC statements. An initial i-Wing pilot program should be conducted at an associate wing that has already established a record of success. [Chapter 3]
- 14—Key Leadership Positions:** The Air Force should ensure that integrated units are filled competitively by qualified Airmen irrespective of component, but key deputy positions (such as vice, deputy, subordinate echelon commander) should always be filled by an “opposite” component member. [Chapter 3]
- 15—Effective Control Measures:** The Air Force must establish effective control measures to ensure that both Active and Air Reserve Component Airmen have adequate paths and opportunities for advancement and career development. [Chapter 3]
- 16—Awards, Decorations, and Promotions:** The integrated chain of command must take special care in managing personnel issues such as awards and decorations, promotions, and assignment opportunities, both for those who seek to compete for increasingly higher levels of responsibility and for those who opt to sustain longevity in exercising and developing a particular skill set. [Chapter 3]
- 17—Professional Military Education Positions:** Commander, Air University should develop a new baseline for its student and instructor positions to achieve a proportionate representation of the components on faculty and in the annual student body by FY 2018. [Chapter 3]
- 18—Total Force Competency Standard:** Commander, Air Education and Training Command (AETC) in coordination with the Assistant Secretary of the Air Force for Manpower and Reserve Affairs and AF/A1, should develop a Total Force competency standard for officers, non-commissioned officers, and enlisted Airmen across all specialties and career fields before the end of FY 2016. Commander AETC should conduct a comprehensive curriculum review, similar to the one it completed for the Nuclear Enterprise in 2008–2009, to support professional and technical military education goals necessary for Airmen of all components to acquire cross-component skills, knowledge, comprehension, and analytic capability. The review should be completed by FY 2017, and the Chief of Staff of the Air Force should ensure a Total Force competency standard is implemented by FY 2018, such that it is available and resourced for all Airmen. [Chapter 3]
- 19—Access to Non-Resident Education:** Commander, AETC should ensure that revised curriculum and competency standards are achievable by appropriately structured non-resident education programs equally accessible to personnel of all components. This must include special attention to the numerous ancillary training requirements that impose extraordinary burdens on traditional Air Reserve Component Airmen who must complete much of their training via distance learning but lack time and access to required information technologies to complete those training requirements in a timely manner while on drill status. A goal should be set to reduce unnecessary training requirements and to add flexibility to acceptable methods of completing those requirements that remain. [Chapter 3]

- 20—Increase ARC Capacity:** The Air Force should increase its utilization of the Air Reserve Component by increasing the routine employment of ARC units and individuals to meet recurring rotational requirements. The measure of success in this increased use of the ARC should be the execution of at least 13,000 man years annually. [Chapter 4]
- 21—Operational ARC Funding:** The Air Force should include in all future budget submissions a specific funding line for “operational support by the Air Reserve Component” to clearly identify and program those funds intended to permit routine, periodic employment of the ARC either as volunteers or under the authority of 10 U.S.C. §12304b. [Chapter 4]
- 22—Council of Governors:** The Secretary of Defense should revise its agreement with the Council of Governors to enable Air Force leadership to consult directly with the Council of Governors when requested, including discussion of pre-decisional information. [Chapter 4]
- 23—Non-Disclosure Agreements:** The Secretary of the Air Force should discontinue use of Non-Disclosure Agreements in the corporate process. [Chapter 4]
- 24—State Adjutants General:** The Secretary of the Air Force should continue to advance current informal practice and mechanisms for engaging with The Adjutants General in development of the Air Force Program. [Chapter 4]
- 25—Cyberspace Airmen:** As it increases the number of Airmen in career fields associated with Cyberspace, the Air Force should fill much of that demand with the Reserve Components, which are well situated to recruit and retain from the specialized talent available in the commercial cyber labor market. [Chapter 4]
- 26—Space Domain:** The Air Force should build more Air Reserve Component opportunities in the space domain, especially in predictable continuity of operations missions and round-the-clock shift work. [Chapter 4]
- 27—GIISR Billets:** The Air Force should integrate all of its new Global Integrated Intelligence, Surveillance, and Reconnaissance units, and the preponderance of new billets should be for Reservists and Guardsmen. [Chapter 4]
- 28—Special Operations:** The Air Force should increase Air Reserve Component presence in Special Operations through greater integration. [Chapter 4]
- 29—ICBM Mission:** As a pilot program, the Air Force should, by the end of FY 2016, expand Air Reserve Component contributions to the ICBM mission by replicating the 219th Security Forces Squadron model across all three ICBM wings. As lessons are learned, the Air Force should expand the Security Forces model to Missile Maintenance functions between FY 2017 and FY 2019. The Air Force should also shift the Missile Field Helicopter mission to the Reserve Components. [Chapter 4]
- 30—Instructor Pilots:** The Air Force should replace some of the 1,800 Active instructor pilots with prior-service volunteers from the Air Reserve Component who would not rotate back to operational squadrons. [Chapter 4]
- 31—Homeland Security and Disaster Assistance:** The President should direct the Departments of Defense and Homeland Security to develop, in full coordination with the Council of Governors, national requirements for Homeland Security and Disaster Assistance, both foreign and domestic. [Chapter 4]
- 32—Homeland Defense and DSCA:** DoD and the Air Force should treat Homeland Defense and DSCA as real priorities and Governors as essential stakeholders in planning processes. [Chapter 4]
- 33—Duty Statuses:** Congress should reduce the number of separate duty statuses from more than 30 to no more than six, as has been recommended by the Quadrennial Review of Military Compensation and, more recently, by the Reserve Forces Policy Board. Reducing the number of duty status categories will make it easier for Air Reserve Component Airmen to serve in an operational capacity. The Air Force can implement this change in a way that does not diminish the overall compensation of Air Reserve Component members. Numerous provisions in current law that may require change are identified in Appendix J. [Chapter 5]
- 34—Integrated Personnel Management:** The Air Force should unify personnel management for all three components under a single integrated organization (A1) in the Headquarters Air Staff. This is a different concept than an office that would oversee and integrate the activities of three separate component A1s. The Air Force should aggressively implement the “3 to 1” process but widen and amplify the effort to include integration of the three components’ personnel management processes for such matter as recruiting, assignments, force development, and



force management. A unified personnel management organization could best manage the portfolio of Air Force Specialty Codes and achieve the most favorable utilization rates, retention rates, and human capital cost controls. [Chapter 5]

- 35—Integrated Pay and Personnel System:** The Air Force should accelerate the development of an Integrated Pay and Personnel System (AF-IPPS). The goal should be completion not later than 2016. The Air Force should ensure that this single system is capable of properly producing orders as well as accounting for and paying Airmen from all three components with a focus on providing a clear, simple structure under which the Air Force calls Air Reserve Component members to serve. This will result in an increased ability to plan, program for, and gain access to Air Reserve Component Airmen for any training and operational purposes. It will provide the means to capture the legal purpose and method of reimbursement of the Reserve Components for tracking and analyzing data. [Chapter 5]
- 36—PERSTEMPO Metric:** The Air Force should use a single metric for measuring the personnel tempo and stress on its forces, both Active and Reserve. The Commission also recommends that the Air Force utilize this “PERSTEMPO, stress on the force” metric to determine sustainable levels of employment for the Active Component, and for the Reserve Components when partial mobilization authority is not used. [Chapter 5]
- 37—Non-Deployment PERSTEMPO:** USD(P&R) should update the definition of a non-deployment PERSTEMPO event for the Reserve Components to include those situations where placement on active duty orders under either Title 10 or Title 32 causes the Air Reserve Component member to be away from his or her civilian job or attendance at school. [Chapter 5]
- 38—PERSTEMPO and AF-IPPS:** The Air Force should include PERSTEMPO accounting in AF-IPPS. [Chapter 5]
- 39—Continuum of Service:** The Total Force Continuum should develop and supervise implementation of a pilot project for the implementation of Continuum of Service to commence by Oct. 1, 2014. [Chapter 5]
- 40—Active Duty Service Commitments:** The Air Force should revise the rules for current Active Duty Service Commitments to enable members to meet the commitment in some combination of Active, Reserve, and Guard service. [Chapter 5]
- 41—Multiple Career Track Options:** The Air Force should develop a new service construct consisting of multiple career track options, each with different high-year tenure controls, where such additional tenure serves the needs of the Air Force. At a minimum, the following career tracks require study: tactical or technical excellence and enterprise leadership. [Chapter 5]
- 42—“Up or Out”:** Congress should amend restrictive aspects of current statutes that mandate “up-or-out” career management policies to enable the Air Force to retain Airmen of all components actively working in career fields where substantial investment in training and career development has been made and where it serves the needs of the Air Force. [Chapter 5]

## APPENDIX C

## RECOMMENDATIONS: RESPONSIBLE OFFICIAL

**President**

**31—Homeland Security and Disaster Assistance:** The President should direct the Departments of Defense and Homeland Security to develop, in full coordination with the Council of Governors, national requirements for Homeland Security and Disaster Assistance, both foreign and domestic. [Chapter 4]

**Congress**

**2—Budgeting Flexibility:** In the Fiscal Year (FY) 2015 National Defense Authorization Act and Defense Appropriations Act, Congress should allow DoD increased flexibility in applying budget cuts across budget categories, including installations. [Chapter 2]

**4—Infrastructure:** The Air Force should consider, and Congress should allow, the closing or warm basing of some installations. [Chapter 2]

**5—Air Force Reserve Command:** Congress should amend 10 U.S.C. §10174 to retain the statutory rank, roles, responsibilities, and functions of the Director, Air National Guard, and Chief of the Air Force Reserve but disestablish the Air Force Reserve Command. The Air Force should inactivate the Reserve Numbered Air Forces, wings, and squadrons. The roles, responsibilities, and functions of disestablished organizations should be assumed by the Secretary of the Air Force, Headquarters Air Force, and MAJCOMS, all of which will have increased representation by Air Reserve Component Airmen, as determined by the Secretary of the Air Force. [Chapter 3]

**33—Duty Statuses:** Congress should reduce the number of separate duty statuses from more than 30 to no more than six, as has been recommended by the Quadrennial Review of Military Compensation and, more recently, by the Reserve Forces Policy Board. Reducing the number of duty status categories will make it easier for Air Reserve Component Airmen to serve in an operational capacity. The Air Force can implement this change in a way that does not diminish the overall compensation of Air Reserve Component members.

Numerous provisions in current law that may require change are identified in Appendix J. [Chapter 5]

**42—“Up or Out”:** Congress should amend restrictive aspects of current statutes that mandate “up-or-out” career management policies to enable the Air Force to retain Airmen of all components actively working in career fields where substantial investment in training and career development has been made and where it serves the needs of the Air Force. [Chapter 5]

**Secretary of Defense**

**1—Cost Approach:** DoD should formally adopt the “fully burdened cost” approach to calculating military personnel costs, and it should apply analytic methods that focus on appropriate outputs along with life-cycle costs. The Department should then modify DoD Instruction 7041.04 to establish a common list of the various elements of pay, benefits, and other costs that contribute to the “fully burdened” or “life cycle” cost that all services would then use in calculating the cost of personnel. This will enable the Air Force to assess accurately force structure issues and choices in terms of fully burdened, total life-cycle costs of human capital, as well as operating costs of units and aircraft. [Chapter 2]

**22—Council of Governors:** The Secretary of Defense should revise its agreement with the Council of Governors to enable Air Force leadership to consult directly with the Council of Governors when requested, including discussion of pre-decisional information. [Chapter 4]

**32—Homeland Defense and DSCA:** DoD and the Air Force should treat Homeland Defense and DSCA as real priorities and Governors as essential stakeholders in planning processes. [Chapter 4]

**37—Non-Deployment PERSTEMPO:** USD(P&R) should update the definition of a non-deployment PERSTEMPO event for the Reserve Components to include those situations where placement on active duty orders under either Title 10 or Title 32 causes the Air Reserve Component member to be away from his or her civilian job or attendance at school. [Chapter 5]

### Secretary of the Air Force

- 3—Resourcing the Reserve Components:** To ensure the Air Force leverages full capacity of all components of the force, in its FY 2016 Program Objective Memorandum, the Air Force should plan, program, and budget for increased reliance on the Reserve Components. The Commission recommends: (1) the Air Force should include in all future budget submissions a specific funding line for “operational support by the Air Reserve Component” to clearly identify those funds programmed for routine periodic employment of the ARC either as volunteers or under the authority of 10 U.S.C. §12304b; (2) in its future budget submissions the Air Force should program for approximately 15,000 man years of operational support annually by the Air Reserve Component; (3) in succeeding years, the Air Force should monitor the execution of this program element to ensure it is utilizing the Air Reserve Component to its fullest extent. [Chapter 2]
- 6—Staff Integration:** The Air Force should integrate the existing staffs of the Headquarters Air Force, the Air Force Reserve, and Air National Guard, similar to the principles recommended by the Total Force Task Force. [Chapter 3]
- 7—AFR Unit Integration:** The Chief of Staff of the Air Force should direct the integration of Air Force Reserve associations of flights, squadrons, groups, and wings into corresponding Active Component organizations in order to eliminate the current redundant organizational overhead found in classic associations. [Chapter 3]
- 8—Full-Time and Part-Time Mix:** The combination of full-time and part-time positions should be determined for each unit depending on weapon system requirements, deployment, and rotation schedule based on optimum matching of the needs of the Air Force, family, and employers. The unit should determine this composition in accordance with the mission assigned and in line with the full-time and part-time ratios represented by the current, independent, Active Air Force and Air Force Reserve units currently sharing missions. [Chapter 3]
- 9—ANG Unit Integration:** The Chief of Staff of the Air Force should direct the integration of Air Force flights, squadrons, groups, and wings into corresponding Air National Guard organizations in order to eliminate the current redundant organizational overhead found in active associations. [Chapter 3]
- 10—ANG Unit Size:** The Chief of Staff of the Air Force, in coordination with the Director of the Air National Guard, should change wing-level organizations to group organizations where the Airmen population and associated equipment are more realistically sized at the group level. The unnecessary recent growth of ANG wings from groups created excessive overhead positions that detract from availability to directly support training, peacetime, and wartime missions. [Chapter 3]
- 11—Concurrent Fielding of Equipment:** As the Air Force acquires new equipment, force integration plans should adhere to the principle of proportional and concurrent fielding across the components. This means that, in advance of full integration, new equipment will arrive at Air Reserve Component units simultaneously with its arrival at Active Component units in the proportional share of each component. As the Air Force Reserve and Active Component become fully integrated, the Air Force should ensure that the Air National Guard receives new technology concurrent with the integrated units. The Air Force should no longer recapitalize by cascading equipment from the Active Component to the Reserve Components. [Chapter 3]
- 12—Policy Revisions:** Integrating units will require manpower and personnel policy revisions. The Air Force should modify AFI 90-1001 “Responsibilities for Total Force Integration” to establish selection and assignment criteria, the minimum proportion of leadership positions that must be filled by the associating components, and the methods to ensure compliance. The AF/A1 and Air Force Personnel Center should then reassign Airmen in disestablished Air Force Reserve units to integrated Title 10 units composed of Active Air Force, Reserve, full-time and part-time Airmen. [Chapter 3]
- 13—DOC Statements:** The Air Force should discontinue the practice of separate designated operational capability (DOC) documents for Active and Reserve units of the same type and place the i-Units under single DOC statements. An initial i-Wing pilot program should be conducted at an associate wing that has already established a record of success. [Chapter 3]
- 14—Key Leadership Positions:** The Air Force should ensure that integrated units are filled competitively by qualified Airmen irrespective of component, but key deputy positions (such as vice, deputy, subordinate echelon commander) should always be filled by an “opposite” component member. [Chapter 3]
- 15—Effective Control Measures:** The Air Force must establish effective control measures to ensure that both

Active and Air Reserve Component Airmen have adequate paths and opportunities for advancement and career development. [Chapter 3]

**16—Awards, Decorations, and Promotions:** The integrated chain of command must take special care in managing personnel issues such as awards and decorations, promotions, and assignment opportunities, both for those who seek to compete for increasingly higher levels of responsibility and for those who opt to sustain longevity in exercising and developing a particular skill set. [Chapter 3]

**17—Professional Military Education Positions:** Commander, Air University should develop a new baseline for its student and instructor positions to achieve a proportionate representation of the components on faculty and in the annual student body by FY 2018. [Chapter 3]

**18—Total Force Competency Standard:** Commander, Air Education and Training Command (AETC) in coordination with the Assistant Secretary of the Air Force for Manpower and Reserve Affairs and AF/A1, should develop a Total Force competency standard for officers, non-commissioned officers, and enlisted Airmen across all specialties and career fields before the end of FY 2016. Commander AETC should conduct a comprehensive curriculum review, similar to the one it completed for the Nuclear Enterprise in 2008–2009, to support professional and technical military education goals necessary for Airmen of all components to acquire cross-component skills, knowledge, comprehension, and analytic capability. The review should be completed by FY 2017, and the Chief of Staff of the Air Force should ensure a Total Force competency standard is implemented by FY 2018, such that it is available and resourced for all Airmen. [Chapter 3]

**19—Access to Non-Resident Education:** Commander, AETC should ensure that revised curriculum and competency standards are achievable by appropriately structured non-resident education programs equally accessible to personnel of all components. This must include special attention to the numerous ancillary training requirements that impose extraordinary burdens on traditional Air Reserve Component Airmen who must complete much of their training via distance learning but lack time and access to required information technologies to complete those training requirements in a timely manner while on drill status. A goal should be set to reduce unnecessary training requirements and to

add flexibility to acceptable methods of completing those requirements that remain. [Chapter 3]

**20—Increase ARC Capacity:** The Air Force should increase its utilization of the Air Reserve Component by increasing the routine employment of ARC units and individuals to meet recurring rotational requirements. The measure of success in this increased use of the ARC should be the execution of at least 13,000 man years annually. [Chapter 4]

**21—Operational ARC Funding:** The Air Force should include in all future budget submissions a specific funding line for “operational support by the Air Reserve Component” to clearly identify and program those funds intended to permit routine, periodic employment of the ARC either as volunteers or under the authority of 10 U.S.C. §12304b. [Chapter 4]

**23—Non-Disclosure Agreements:** The Secretary of the Air Force should discontinue use of Non-Disclosure Agreements in the corporate process. [Chapter 4]

**24—State Adjutants General:** The Secretary of the Air Force should continue to advance current informal practice and mechanisms for engaging with The Adjutants General in development of the Air Force Program. [Chapter 4]

**25—Cyberspace Airmen:** As it increases the number of Airmen in career fields associated with Cyberspace, the Air Force should fill much of that demand with the Reserve Components, which are well situated to recruit and retain from the specialized talent available in the commercial cyber labor market. [Chapter 4]

**26—Space Domain:** The Air Force should build more Air Reserve Component opportunities in the space domain, especially in predictable continuity of operations missions and round-the-clock shift work. [Chapter 4]

**27—GIISR Billets:** The Air Force should integrate all of its new Global Integrated Intelligence, Surveillance, and Reconnaissance units, and the preponderance of new billets should be for Reservists and Guardsmen. [Chapter 4]

**28—Special Operations:** The Air Force should increase Air Reserve Component presence in Special Operations through greater integration. [Chapter 4]

**29—ICBM Mission:** As a pilot program, the Air Force should, by the end of FY 2016, expand Air Reserve Component contributions to the ICBM mission by replicating the 219th Security Forces Squadron model



across all three ICBM wings. As lessons are learned, the Air Force should expand the Security Forces model to Missile Maintenance functions between FY 2017 and FY 2019. The Air Force should also shift the Missile Field Helicopter mission to the Reserve Components. [Chapter 4]

- 30—Instructor Pilots:** The Air Force should replace some of the 1,800 Active instructor pilots with prior-service volunteers from the Air Reserve Component who would not rotate back to operational squadrons. [Chapter 4]
- 34—Integrated Personnel Management:** The Air Force should unify personnel management for all three components under a single integrated organization (A1) in the Headquarters Air Staff. This is a different concept than an office that would oversee and integrate the activities of three separate component A1s. The Air Force should aggressively implement the “3 to 1” process but widen and amplify the effort to include integration of the three components’ personnel management processes for such matter as recruiting, assignments, force development, and force management. A unified personnel management organization could best manage the portfolio of Air Force Specialty Codes and achieve the most favorable utilization rates, retention rates, and human capital cost controls. [Chapter 5]
- 35—Integrated Pay and Personnel System:** The Air Force should accelerate the development of an Integrated Pay and Personnel System (AF-IPPS). The goal should be completion not later than 2016. The Air Force should ensure that this single system is capable of properly producing orders as well as accounting for and paying Airmen from all three components with a focus on providing a clear, simple structure under which the Air Force calls Air Reserve Component members to serve. This will result in an increased ability to plan, program for, and gain access to Air Reserve Component Airmen for any training and operational purposes. It will provide the means to capture the legal purpose and method of reimbursement of the Reserve Components for tracking and analyzing data. [Chapter 5]
- 36—PERSTEMPO Metric:** The Air Force should use a single metric for measuring the personnel tempo and stress on its forces, both Active and Reserve. The Commission also recommends that the Air Force utilize this “PERSTEMPO, stress on the force” metric to determine sustainable levels of employment for the Active Component, and for the Reserve Components when partial mobilization authority is not used. [Chapter 5]
- 38—PERSTEMPO and AF-IPPS:** The Air Force should include PERSTEMPO accounting in AF-IPPS. [Chapter 5]
- 39—Continuum of Service:** The Total Force Continuum should develop and supervise implementation of a pilot project for the implementation of Continuum of Service to commence by Oct. 1, 2014. [Chapter 5]
- 40—Active Duty Service Commitments:** The Air Force should revise the rules for current Active Duty Service Commitments to enable members to meet the commitment in some combination of Active, Reserve, and Guard service. [Chapter 5]
- 41—Multiple Career Track Options:** The Air Force should develop a new service construct consisting of multiple career track options, each with different high-year tenure controls, where such additional tenure serves the needs of the Air Force. At a minimum, the following career tracks require study: tactical or technical excellence and enterprise leadership. [Chapter 5]

## APPENDIX D

## ADDITIONAL VIEW ON IMPACT OF DOD IMPLEMENTATION OF THE FEDERAL ADVISORY COMMITTEE ACT

*In addition to, and separately from, the views of the National Commission on the Structure of the Air Force that are expressed in this report, the undersigned add the following statement in the hope that it will be useful to Congress and the President in the conduct of future efforts of this type.*

Congress created the National Commission on the Structure of the Air Force in the National Defense Authorization Act. It set forth the organization and appointment of commission members, provided specific provisions for calling and holding meetings, establishment of a quorum, selection of a Chair and Vice Chair, and specified certain personnel provisions. Air Force funds were provided, and the Commission was directed to report to the President and the congressional defense committees by February 1, 2014, exactly nine months from the date of the first Commission meeting.

At that first meeting, the Department of Defense's Director of Administration and Management advised that his office was the "sponsor" of the Commission, that the Federal Advisory Committee Act (FACA) would govern the work of the Committee, and that a "Designated Federal Officer" (DFO) was assigned to the Commission with the responsibility of monitoring compliance with FACA. As the Commission proceeded with its work, it became increasingly clear that the DoD interpretation of FACA's purpose would have a significant, and frequently negative, impact on the Commission's work.

All Commissioners have consistently made strong and sincere efforts to comply with the FACA restrictions announced by the DFO. The Commissioners determined in their first meeting their desire to actively solicit the views of government leaders and the military and to provide members of the public a full opportunity to be heard and to be aware of the Commission's progress. The Commission also committed itself to the maintenance of a full and comprehensive record of its work and a publicly available archive of the papers it generated and collected.

When one looks to the U. S. Supreme Court's analysis of what Congress intended from FACA, the following quotation seems both clear and illustrative:

*"However, since FACA was enacted to cure specific ills—particularly the wasteful expenditure of public funds for worthless committee meetings and biased proposals by special interest groups—it is unlikely that Congress intended the statute to cover every formal and informal consultation between the President or an Executive agency and a group rendering advice." Public Citizen, et al. v. Dept. of Justice, 491 U.S. 440 (1989)*

There has been no indication that the Department of Defense was concerned that the Commission was wastefully expending public funds, nor that it would be subject to biased proposals by special interest groups, but the Department's FACA interpretations severely constrained Commissioners when it came to scheduling hearings and writing our report. Two interpretations caused the most problems.

- Any discussion among a quorum of commissioners was deemed to be a "deliberation" that required these deliberations to be held as public hearings, with announcements in the Federal Register and monitoring by the DFO. Since more than 30-day lead times were involved to complete those requirements, Commissioners were unable to respond to some emerging issues as they arose.

- “Deliberations” were also said to include any discussion involving two or more commissioners, even if the discussion was whether to use “happy” or “glad” in describing in the report a recommendation we had already agreed upon. DoD interpreted FACA to prevent Commissioners from exchanging drafts of the report among themselves. DoD counsel directed the Commissioners to establish a “choke point” (the Executive Director) to whom they could communicate individually and who could then send their drafts and comments to the other Commissioners for comment back to him. How this cumbersome process served the public interest is not clear.

Since nothing in the statute that created the Commission made its work subject to FACA, and since many of the specific provisions in the statute are contrary to the processes contained in FACA, it is reasonable to question whether FACA should have ever been invoked. But the Department of Defense position has consistently been “if the statute doesn’t exempt you from FACA, you are covered by FACA.” We recommend that Congress be aware of this interpretation when it considers the creation of future commissions to work on Defense-related issues.

The restrictive interpretations applied by DoD have not derailed the work of the Commission. Fortunately, the men and women appointed to the Commission remained steadfast and refused to allow those restrictive interpretations to deter them from completing their task and delivering well researched and reasoned recommendations to the President and the Congress within the allotted time. However, future deliberative and collaborative efforts of this type would be aided by clearly stated Congressional intent permitting the Commissioners to enter into deliberative dialogue in the same manner as the legislative and executive branches do when they discharge their public trust.

Respectfully submitted,

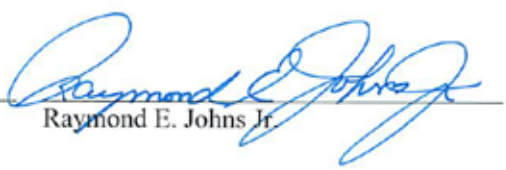
  
Dennis McCarthy, Chair

  
Erin C. Conaton, Vice Chair

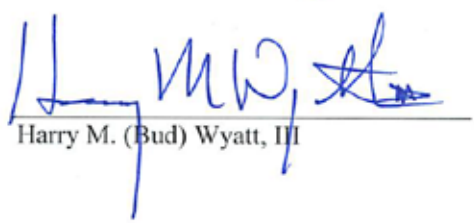
  
Les Brownlee

  
Janine Davidson

  
Margaret C. Harrell

  
Raymond E. Johns Jr.

  
F. Whitten Peters

  
Harry M. (Bud) Wyatt, III





# ADDITIONAL VIEWS OF COMMISSIONERS R.L. (LES) BROWNLEE AND MARGARET C. HARRELL ON THE REPORT OF THE NATIONAL COMMISSION ON THE STRUCTURE OF THE AIR FORCE

*In addition to, and separately from, the views of the National Commission on the Structure of the Air Force that are expressed in this report, the undersigned adds the following statement to clarify that the report of the National Commission on the Structure of the Air Force applies only to the U.S. Air Force, and that the recommendations of the Commission are not directly applicable to the other military services, including their Active and Reserve Components.*


These views are provided, not to voice a disagreement with any particular issue, finding, or recommendation in the Commission's report, but to emphasize and make clear that the findings and recommendations provided in this report were based on and are intended to be applied solely to the U.S. Air Force, including both its Active and Reserve Components.


While the U.S. Army faces a similarly restrictive budgetary environment and difficult reductions in personnel end strength, it is clear that Congress, in creating the National Commission on the Structure of the Air Force, intended the Commission to focus its attention solely on the U.S. Air Force. The recommendations within the Commission's report should not be reflexively extrapolated from this report with the intent of applying these recommendations to any other U.S. military service or any of their Active or Reserve Components.

The differences among the military services and the characteristics of their Reserve Components are significant. Only the Army and the Air Force have Reserve Components that include both a Reserve element as well as a National Guard element. The Navy and the Marine Corps only have relatively small Reserve forces. A likely misapplication, therefore, might be to attempt to apply to the Army some of the report's recommendations that are intended only for the Air Force.

The primary difference between the Army and the Air Force underlying the foundational conclusions cited in this report is the level of readiness and responsiveness the Air Force accords to its Reserve Component units. The Reserve Component of the Air Force, because it is able to maintain the same high standards of readiness as its Active Component, may be called upon for immediate combat deployments and high-priority missions. Army Reserve Component units, on the other hand, are generally unable to attain the same high levels of readiness as Army Active Component units. Collective training requirements for Army units (not generally required for Air Force flying units) and the limited number of training days available to Army Reserve Component units make it extremely difficult for them to reach and maintain the high levels of readiness required for Army Active Component units. Thus, before Army Reserve Component formations can be committed to high-priority missions or deployed to combat areas, they must undergo periods of supplemental combat training—primarily, collective training—in order to meet required levels of combat readiness.

Respectfully submitted,

  
Les Brownlee

  
Margaret C. Harrell

## APPENDIX E

# CLASSIFIED ANNEX CONTENTS

The classified annex is a compendium of the major classified source documents, testimony notes, briefings and staff products that served the following purposes:

- Described the strategic environment within which the Air Force will operate;
- Delineated the planning guidance and fiscal constraints that bounded Commissioner deliberations and eventual recommendations;
- Presented analysis to Commissioners providing alternative solutions to achieve mandated resource targets, accomplished by generating different assumptions, modifying tools, and developing comparative, computational assessments;
- Provided the framework for Commissioner and staff team preparation and participation in the war game.

### [TABLE OF CONTENTS FOR CLASSIFIED FILE](#)

#### **Report: Chapter 1 – Introduction**

Core Function Integration Guides  
 FY 2014 Defense Planning Guidance  
 War Game Volume  
 Advanced Decision Support Tool (ADST) with examples  
 National Defense Strategy  
 National Security Strategy  
 Integrated Priority Lists  
 Integrated Security Construct (ISC, Warfare Scenarios)  
 Strategic Framework  
 Testimony notes from Major General Anthony J. Rock (USAF), Vice Director, Strategic Plans and Policy (J-5), The Joint Chiefs of Staff  
 Testimony notes from Mr. David Ochmanek, Deputy Assistant Secretary of Defense for Force Development, Office of the Secretary of Defense

#### **Report: Chapter 2 – Resources**

FY 2015 Alt-POM/POM, Assistant Secretary of Defense for Reserve Affairs (ASD-RA)  
 Testimony notes from Cost Assessment and Program Evaluation (CAPE)

#### **Report: Chapter 3 – Rebalancing**

Advanced Decision Support Tool (ADST)  
 Cost of an Airman  
 Air Force Units Installations and Priorities Document  
 Testimony notes from General Charles H. Jacoby Jr., Commander, U.S. NORTHCOM  
 Testimony notes from Air Force Total Force Task Force general officers  
 ICBM/Western Air Defense Sector staff study  
 Commission staff briefing on Space  
 Management Control Activity briefing—CAPE

#### **Report: Chapter 4 – Sizing and Shaping**

Core Function Integration Guides  
 FY 2015 Alt-POM/POM ASD-RA  
 Advanced Decision Support Tool (ADST)  
 1st Helo Squadron example  
 Nuclear Deterrence Option (NDO) Helo Support  
 NCSAF Cyber Brief  
 24th Air Force Cyber Briefing  
 Notes from CYBERCOM Reserve Component Advisors

#### **Report: Chapter 5 – Managing**

Testimony notes from MG Schweizer on GPM Process

## APPENDIX F

# COMMISSION ACTIVITIES

### COMMISSIONER SITE VISITS

Greenville, S.C., June 17, 2013, public hearing  
 Joint Base McGuire-Dix-Lakehurst, N.J., July 16, 2013, with  
 public hearing in Toms River  
 Wright-Patterson AFB, Ohio, July 29, 2013  
 Springfield ANGB, Ohio, July 29, 2013  
 Rickenbacker ANGB, Ohio, July 30, 2013  
 Columbus, Ohio, July 30, 2013, public hearing  
 Mansfield-Lahm Airport ANGB, Ohio, July 31, 2013  
 Joint Base Langley-Eustis AFB, Va., August 5, 2013  
 Tinker AFB, Okla., August 20, 2013, with public hearing in  
 Oklahoma City  
 Alpena CRTC, Mich., September 13, 2013  
 Selfridge ANGB, Mich., September 14, 2013, with public  
 hearing in Chesterfield Township  
 Joint Base Pearl Harbor-Hickam, Hawaii, September 22-23,  
 2013  
 Hurlburt Field, Fla., September 30, 2013

### COMMISSIONER CAPITOL REGION HEARINGS

Arlington, Va., June 3, 2013  
 Rayburn House Office Building, June 4, 2013  
 Arlington, Va., June 25, 2013 (closed)  
 Arlington, Va., June 26, 2013  
 Arlington, Va., July 22, 2013 (closed)  
 Arlington, Va., July 23, 2013  
 Arlington, Va., August 27, 2013  
 Arlington, Va., September 26, 2013 (closed)  
 Arlington, Va., October 14, 2013  
 Arlington, Va., October 24, 2013 (partially closed)  
 Arlington, Va., October 25, 2013  
 Arlington, Va., November 5, 2013 (closed)  
 Arlington, Va., November 12, 2013 (closed)  
 Arlington, Va. November 18-19, 2013 (closed)  
 Arlington, Va. December 3-5, 2013 (closed)  
 Arlington, Va., December 10, 2013 (closed)  
 Arlington, Va., December 17, 2013 (closed)  
 Arlington, Va., January 8, 2014 (closed)  
 Arlington, Va., January 9, 2014

### STAFF-ONLY SITE VISITS

USNORTHCOM, Peterson AFB, Colo., September 9–11,  
 2013  
 Maxwell AFB, Ala., September 25–27, 2013: School of  
 Advanced Air and Space Studies, Air War College, Air  
 Force Research Institute  
 USTRANSCOM/AMC, Scott AFB, Ill., October 21, 2013  
 Joint Base San Antonio-Randolf, Texas, November 12–13,  
 2013  
 Joint Base San Antonio-Lackland, Texas, November 12–13,  
 2013  
 Hanscom AFB, Mass., November 21, 2013:

### STAFF-ONLY MEETINGS

Air Staff (A5XW, A3CX, A6CX), August 22, October 17,  
 November 26, 2013  
 National Governors Association, August 29, 2013  
 Council of Governors, August 29, 2013  
 National Guard Association of the United States, September  
 15, 2013  
 Gov. Rick Snyder's staff, September 20, 2013  
 Michigan Chief Information Officer, September 26, 2013  
 Deputy Assistant Secretaries of Defense for Homeland  
 Defense Integration and DSCA and for Homeland  
 Defense Strategy and Force Planning, September 26, 2013  
 Ohio National Guard leaders (cyber issues), October 22,  
 2013  
 Maryland National Guard leaders (cyber issues), October 29,  
 2013  
 USSOCOM (at Pentagon), October 29, 2013  
 Director, Civil Support, Assistant Secretary of Defense for  
 Homeland Defense, November 11, 2013  
 USCYBERCOM, November 13, 2013  
 USSOUTHCOM (at Pentagon), December 3, 2013

**PUBLIC COMMENTS**

The Commission received 256 public comments from the following sources:

Congressional	17
State and local officials	18
Current military	15
<i>U.S. Air Force</i>	10
<i>Adjutants General</i>	5
General Public	206
<i>Industry</i>	82
<i>(identifying themselves with their business interest or as Chamber of Commerce)</i>	
<i>Academia</i>	4
<i>Former military</i>	21
<i>All other</i>	94
<i>Not Germane</i>	5
<i>(unrelated to Commission's mission)</i>	



## APPENDIX G

# TESTIMONY AND ORAL PUBLIC COMMENTS TO THE COMMISSION

### **TESTIMONY AND PUBLIC ORAL COMMENTS BEFORE THE COMMISSION AT OPEN MEETINGS**

#### ***Rayburn House Office Building, Washington D.C., June 4, 2013***

Major General William D. Wofford (ARNG), The Adjutant General of Arkansas and President, Adjutants General Association of the United States

General (Ret.) Craig R. McKinley (ANG), President, Air Force Association

Mr. Peter Duffy, Director of Legislation, National Guard Association of the United States

Colonel (Ret.) Walker M. Williams, III (USAF), National President, Reserve Officers Association of the United States

Major General Emmett R. “Buddy” Titshaw Jr. (ANG), The Adjutant General of Florida

Lieutenant General (Ret.) Dick Newton (USAF), Executive Vice President, Air Force Association

Captain (Ret.) Marshall Hanson (USNR), Legislative Director, Reserve Officers Association of the United States

Major General (Ret.) Jim Bankers (USAF), President, Department of Georgia, Reserve Officers Association

Ms. Mary Catherine Ott, Legislative Manager, Air Programs and Cyber Security, National Guard Association of the United States

Major General Howard M. “Mike” Edwards (ANG), The Adjutant General of Colorado

Major General (Ret.) Paul Weaver (ANG), former Director of the Air National Guard

#### ***Drury Inn Ballroom - Greenville, South Carolina, June 17, 2013***

Major General Robert E. Livingston Jr. (ARNG), The Adjutant General of South Carolina

Major General Timothy Orr (ARNG), The Adjutant General of Iowa, representative to the Council of Governors

General Don Dunbar (ANG), The Adjutant General of Wisconsin, Chairman for Homeland Security and Emergency Response Committee

General William Reddel (ANG), The Adjutant General of New Hampshire

General David Sprynczynatyk (ARNG), The Adjutant General of North Dakota and Director of Emergency Services for North Dakota

Major General Edward Tonini (ANG), The Adjutant General of Kentucky

Major General Emmett R. Titshaw Jr. (ANG), The Adjutant General of Florida, Chair of the TAG’s Committee on Air National Guard Force Structure and Modernization

General Bill Burks (ANG), The Adjutant General of Nevada

General James Campbell (ARNG), The Adjutant General of Maine

Major General (Ret.) Philip Killey (ANG), former Adjutant General of South Dakota and Director of the Air National Guard

*Arlington, Virginia, June 26, 2013*

Major General (Ret.) Arnold Punaro (USMC), Chairman of the Reserve Force's Policy Board but testifying in individual capacity as a long serving military officer, congressional staff leader, and a member of a number of boards and commissions that have had an impact on the Department of Defense.

Major General James N. Stewart (USAF), Director, Reserve Forces Policy Board (Major General Stewart testified before the Commission on August 27, 2013, presenting his personal views; on this day, he testified as a representative of the Reserve Forces Policy Board.)

Colonel Robert Preiss (ARNG), Chief of Staff and Senior Policy Advisor, Army National Guard

Mr. Michael Dominguez, Director of Strategy, Forces, and Resources Division, Institute for Defense Analyses

Dr. Stanley Horowitz, Assistant Division Director, Institute for Defense Analyses

Dr. Colin Doyle, Research Staff Member, Institute for Defense Analyses

Dr. Albert Robbert, Senior Policy Researcher, RAND, former active duty Air Force

Ms. Heather Hogsett, Director, National Governors' Association Health and Homeland Security Committee

Major General Timothy Orr (ARNG), The Adjutant General of Iowa, representative to the Council of Governors

*Toms River, New Jersey: Joint Base McGuire-Dix-Lakehurst, July 16, 2013*

Congressman Jon Runyan, 3rd Congressional District, New Jersey

Brigadier General Robert C. Bolton (ANG), Commander, New Jersey Air National Guard

Mr. David Stapelkamp, Staff Assistant, U.S. Senator Robert Menendez

Mr. Michael Francis, Staff Assistant, U.S. Congressman Frank LoBiondo, 2nd Congressional District, New Jersey

Lieutenant Colonel Mike Cruff (USAF), Commander, 78th Air Refueling Squadron, 514th Air Mobility Wing, JB McGuire-Dix-Lakehurst, New Jersey

Lieutenant Colonel Joseph Wenckus (USAF), Commander, 21st Air Mobility Operations Squadron, 621st Contingency Response Wing, JB McGuire-Dix-Lakehurst, New Jersey

Lieutenant Colonel Stephen Henske (ANG), Commander, 108th Force Support Squadron, JB McGuire-Dix-Lakehurst, New Jersey

Major Mark Szatkowski (USAF), Commander, 305th Maintenance Squadron, 305th Air Mobility Wing, JB McGuire-Dix-Lakehurst, New Jersey

Chief Master Sergeant Lisa Menser (USAF), Air Reserve Technician, Chief Enlisted Manager, 514th Maintenance Group, JB McGuire-Dix-Lakehurst, New Jersey

Chief Master Sergeant Matt Sanders (USAF), 87th Civil Engineers Squadron, 87th Air Base Wing, JB McGuire-Dix-Lakehurst, New Jersey

Chief Master Sergeant Stephen Zinner (ANG), Superintendent, 204th Intelligence Squadron, New Jersey ANG, JB McGuire-Dix-Lakehurst, New Jersey

Senior Master Sergeant Joey Bailey (USAF), Superintendent, 605th Aircraft Maintenance Squadron, JB McGuire-Dix-Lakehurst, New Jersey

Mr. Joseph Donnelly, Director, Burlington County Board of Chosen Freeholders

Mr. Gerry P. Little, Director, Ocean County Board of Chosen Freeholders

Mr. Lewis Nagy, Executive Director, Defense Enhancement Coalition

Mr. David McKeon, Planning Director, Ocean County, New Jersey

Ms. Nino DePasquale, President, The Armed Forces Heritage House Museum

*Arlington, Virginia, July 23, 2013*

General (Ret.) Ronald R. Fogleman (USAF), former Chief of Staff, U.S. Air Force  
Senator Lisa Murkowski, Alaska  
Lieutenant General Michael R. Moeller (USAF), Air Force Deputy Chief of Staff for Strategic Plans and Programs (A8),  
Headquarters U.S. Air Force  
Major General Joseph G. Balskus (USAF), Military Assistant to the Deputy Chief of Staff for Strategic Plans and Programs  
(A8), Headquarters U.S. Air Force  
Mr. Russell Rumbaugh, Director for Budgeting for Foreign Affairs and Defense, Senior Associate at the Stimson Center  
Mr. Mark Gunzinger, Senior Fellow, Center for Strategic and Budgetary Assessments  
Congressman Steve Palazzo, 4th Congressional District, Mississippi  
Mr. Al Garver, Executive Director, Enlisted Association of the National Guard

*Columbus, Ohio: Wright-Patterson AFB, Mansfield ANG, Springfield ANG, Rickenbacker ANG, July 30, 2013*

The Honorable Mary Taylor, Lieutenant Governor of the State of Ohio  
Major General Deborah Ashenhurst (ARNG), The Adjutant General of Ohio  
Ms. Nancy Dragani, Director, Ohio Emergency Management Agency  
Brigadier General Mark Stephens (ANG), Director of Joint Staff, Ohio National Guard  
State Senator Chris Widener, Senate District 10, Ohio  
State Representative Rick Perales, House District 73, Ohio  
Colonel (Ret.) Robert Decker (ARNG), Chairman, Toledo Military Affairs Commission  
State Senator Frank LaRose, Senate District 27, Ohio  
Lieutenant Colonel Michael Hrynciw (ANG), Operations Flight Commander, 200th Red Horse Squadron,  
Mansfield Lahm ANGB, Ohio  
Major General Joe Logan (ANG), Commander, 200th Red Horse Squadron, Detachment 1, Mansfield Lahm ANGB, Ohio  
Master Sergeant Mike Schaefer (ANG), Recruiting Office Supervisor, 179th Airlift Wing, Mansfield Lahm ANGB, Ohio  
Major Robert Cunningham (ANG), Commander, 179th Maintenance Squadron, Mansfield Lahm ANGB, Ohio  
Major Philip Townsend (USAF), 757th Airlift Squadron, Youngstown ARS, Ohio  
Chief Master Sergeant Troy Rhoades (USAF), Command Chief Master Sergeant, 910th Airlift Wing, Youngstown ARS, Ohio  
Lieutenant Colonel Daniel Sarachene (USAF), Commander, 757th Airlift Squadron, 910th Air Wing, Youngstown ARS, Ohio  
Lieutenant Colonel John Boccieri (USAF), Commander 773rd Air Squadron Assistance Squadron, 910th Airlift Wing,  
Youngstown ARS, Ohio  
Lieutenant Brady Minich (ANG), Maintenance Operation Officer, 121st Air Refueling Wing, Rickenbacker ANGB, Ohio  
Lieutenant Colonel Rob Mitrix (USAF), Commander, 89th Airlift Squadron, 445th Air Wing, Wright-Patterson AFB, Ohio  
Chief Master Sergeant Peri Rogawski (USAF), Command Chief, 444th Airlift Wing, Wright-Patterson AFB, Ohio  
Lieutenant Colonel Eric Kaufman (ANG), 121st Air Refueling Wing, Rickenbacker ANGB, Ohio  
Chief Master Sergeant John Mazza (USAF), 88th Air Base Wing, Wright-Patterson AFB, Ohio  
Lieutenant Colonel Kevin Buddelmeyer (USAF), Chief of Safety, 88th Air Base Wing, Wright-Patterson AFB, Ohio  
Chief Master Sergeant Mark Poole (ANG), Operations Chief, 251st Alderson Reporting Company, Cyber Engineering  
Installation Group, Springfield ANGB, Ohio  
Master Sergeant Paul Wong (ANG), 125th Intelligence Squadron, 178th Fighter Wing, Springfield ANGB, Ohio  
Master Sergeant Steven Rybitski (USAF), Superintendent of Plans and Programs, 88th Security Forces Squadron,  
Wright-Patterson AFB, Ohio  
Lieutenant Colonel Mitchell Richardson (USAF), Commander, 89th Airlift Squadron, Wright-Patterson AFB, Ohio

Mr. Michael Dalby, President and CEO of the Columbus Chamber of Commerce, former Air Force Lieutenant Colonel (Ret.) John McCance (USAF), Air Reserve Technician, Wright-Patterson AFB, Ohio  
 Mr. Jeffrey Hoagland, President and CEO, Dayton Development Coalition  
 State Representative Mike Sheehy, House District 46, Ohio, former U.S. Army, Retired Adjutant General Colonel (Ret.) Joseph E. Zeis Jr. (USAF), Executive Vice President of the Dayton Development Coalition, Chair of the Ohio Air, Space, and Aviation Council

*Oklahoma City: Tinker AFB, August 20, 2013*

Major Scott C. Czuba (USAF), Commander, 552nd Maintenance Squadron, 552nd Air Control Wing, Tinker AFB, Oklahoma  
 Chief Master Sergeant Patrick Wilson (USAF), Superintendent, 552 Air Control Group, 552nd Air Control Wing, Tinker AFB, Oklahoma  
 Major Carl V. Jones III (USAF), Commander, 552nd Aircraft Maintenance Squadron, Tinker AFB, Oklahoma  
 Senior Master Sergeant Taunya Latrice Avery (USAF), Production Supervisor, 507th Aircraft Maintenance Squadron, Tinker AFB, Oklahoma  
 Lieutenant Colonel Alan L. Priest (USAF), Director of Maintenance, 513th Air Control Group, Tinker AFB, Oklahoma  
 Lieutenant Colonel Steven England (USAF), Director of Operations, 970th Airborne Air Control Squadron, Tinker AFB, Oklahoma  
 Major Christopher J. Davis (ANG), Commander, 137th Logistics Readiness Squadron, Will Rogers ANGB, Oklahoma  
 Chief Master Sergeant Jeffrey Glenn Elders (ANG), Superintendent for Flight Line, 137th Air Refueling Wing, Will Rogers ANGB, Oklahoma  
 The Honorable Mary Fallin, Governor of Oklahoma  
 Major General Myles Deering (ARNG), The Adjutant General of Oklahoma  
 Brigadier General Gregory L. Ferguson (ANG), Assistant Adjutant General of Oklahoma  
 Senator James Inhofe, Oklahoma  
 Major General (Ret.) Rita Aragon (ANG), Secretary of the Veterans Administration of Oklahoma, Secretary of the Military, former Commander of the Oklahoma Air Guard  
 Mayor Jack Fry, Mayor, Midwest City, Oklahoma  
 Mr. Kurt Foreman, Executive Vice President of Economic Development, Greater Oklahoma City Chamber of Commerce

*Arlington, Virginia, August 27, 2013*

Major General (Ret.) Tommy Dyches (USAF), Assistant to the Chairman of the Joint Chiefs of Staff for Reserve Matters  
 Major General (Ret.) H.H. “Bugs” Forsythe (USAF), Mobilization Assistant to the Commander, 9th Air Force, Shaw AFB, South Carolina  
 Major General (Ret.) Andy Love (ANG), former Assistant to the Commander of U.S. Northern Command for National Guard Matters  
 Major General (Ret.) Richard A. “Dick” Platt (ANG), former Assistant to the Director of the Air National Guard  
 Major General (Ret.) Frank Scoggins (ANG), former Assistant Adjutant General of the Washington National Guard  
 Major General (Ret.) Andrew Davis (USMC), Executive Director, Reserve Officers Association of the United States  
 Major General James N. Stewart (USAF), (Major General Stewart testified before the Commission on June 26, 2013, as a representative of the Reserve Forces Policy Board; on this day, he presented his personal views.)  
 Dr. Scott Comes, Deputy Director for Program Evaluation, Cost Assessment and Program Evaluation, Office of the Secretary of Defense



Lieutenant General James F. “J.J.” Jackson (USAF), Chief, Air Force Reserve  
Mr. Matthew Schaffer, Deputy Director, Analysis & Integration, Cost Assessment and Program Evaluation,  
Office of the Secretary of Defense

*Selfridge, Michigan, September 14, 2013*

Major General Gregory J. Vadnais (ARNG), The Adjutant General for Michigan  
Brigadier General Leonard Isabelle (ANG), Commander, Michigan Air National Guard  
Colonel Michael T. Thomas (ANG), Commander, 127th Wing, Selfridge ANGB, Michigan  
Colonel Ronald W. Wilson (ANG), Commander, 110th Airlift Wing, W.K. Kellogg ANGB, Michigan  
Colonel Bryan Teff (ANG), Commander, Alpena Combat Readiness Training Center, Michigan  
Colonel Sean Southworth (ANG), Commander, 217th Air Operations Group, W.K. Kellogg ANGB, Michigan  
Lieutenant Colonel Matt Trumble (ANG), Director of Operations, Grayling Air Gunnery Range,  
Alpena Combat Readiness Training Center, Michigan  
Lieutenant Colonel Constantine Leon (ANG), Commander, 127th Comptroller Flight, Selfridge ANGB, Michigan  
Chief Master Sergeant Raymond Carroll (ANG), 127th Civil Engineer Squadron, Selfridge ANGB, Michigan  
Dr. Joe Schwarz, Battle Creek Unlimited, former Member of Congress  
The Honorable Matt Waligora, Mayor of Alpena, Michigan  
Brigadier General (Ret.) Mike Peplinski (ANG), former Commander, Selfridge ANGB, Michigan,  
on behalf of employers of the National Guard  
Colonel (Ret.) Rodger Seidel (ANG), former Commander, W.K. Kellogg ANGB, Michigan  
Ms. Jan Frantz, Executive Director, BC CAL KAL Inland Port Development Corporation  
Mr. Philip Handelman, Historian, Selfridge Base Community Council  
Mr. Bill Servial, Chairman, Economic Development Corporation of Harrison Township  
Mr. Alan Parks, Garrison Manager, U.S. Army Garrison, Detroit Arsenal, was unable to attend but  
submitted a statement to the meeting.  
Captain Chris Kelenske, Deputy Director, Michigan State Police, was unable to attend but  
later submitted his statement as a public comment.

*Arlington, Virginia, October 24–25, 2013*

Lieutenant General James F. “J.J.” Jackson (USAF), Chief, Air Force Reserve  
Lieutenant General Stanley E. Clarke III (USAF), Director, Air National Guard  
Chief Master Sergeant James A. Cody (USAF), Chief Master Sergeant of the Air Force  
Mr. Richard O. Wightman, Principal Deputy Assistant Secretary of Defense for Reserve Affairs  
Mr. Paul Patrick, Deputy Assistant Secretary of Defense for Reserve Affairs (Readiness, Training, and Mobilization)  
Mr. Ronald G. Young, Director (Family and Employer Programs and Policy), Office of the Assistant Secretary of Defense for  
Reserve Affairs  
Mr. Trey Carson, Principal Director (Resources), Office of the Assistant Secretary of Defense for Reserve Affairs  
Mr. Todd Rosenblum, Acting Assistant Secretary of Defense for Homeland Defense and Americas’ Security Affairs  
Mr. Thomas LaCrosse, Director of Defense Support of Civil Authorities, Office of the Assistant Secretary of Defense for  
Homeland Defense and Americas’ Security Affairs  
Chief Master Sergeant Cameron B. Kirksey (USAF), Command Chief Master Sergeant, Air Force Reserve  
Chief Master Sergeant James W. Hotaling (ANG), Command Chief Master Sergeant, Air National Guard

*Arlington, Virginia, January 9, 2014*

The Honorable Deborah Lee James, Secretary of the Air Force

Colonel Ralph J. Waite IV, USAF, Analyst, Tactical Air Forces Division, Cost Assessment and Program Evaluation, Office of the Secretary of Defense

Dr. F. Matthew Woodward, Analyst, Cost Assessment and Program Evaluation, Office of the Secretary of Defense

Ms. Elain Simmons, Director, Land Forces Division, Cost Assessment and Program Evaluation, Office of the Secretary of Defense

Peter DeFluri, Director, Projection Forces Division, Cost Assessment and Program Evaluation, Office of the Secretary of Defense

Dr. Scott Comes, Acting Director, Cost Assessment and Program Evaluation, Office of the Secretary of Defense

**TESTIMONY BEFORE THE COMMISSION AT CLOSED MEETINGS**

*Arlington, Virginia, June 3, 2013*

Lieutenant General James F. “J.J.” Jackson (USAF), Chief, Air Force Reserve

Lieutenant General Stanley E. Clarke III (USAF), Director, Air National Guard

The Honorable Michael B. Donley, Secretary of the Air Force

General Mark A. Welsh III (USAF), Chief of Staff of the U.S. Air Force

Major General Anthony Rock (USAF), Vice Director, Strategic Plans and Policy (J-5), The Joint Chiefs of Staff

Ms. Lisa Disbrow, Vice Director, Force Structure, Resources, and Assessment (J-8), The Joint Chiefs of Staff

Mr. Michael Altomare, Chief, Force Division (J-8), The Joint Chiefs of Staff

*Arlington, Virginia, June 25, 2013*

Ms. Christine Fox, Director, Cost Assessment and Program Evaluation

General Frank J. Grass (USA), Chief, National Guard Bureau

Major General Brian Meenan (USAF), Total Force Task Force (TF2)

Major General John Posner (USAF), Total Force Task Force (TF2)

Major General Joseph G. Balskus (USAF), Total Force Task Force (TF2)

*Arlington, Virginia, July 22, 2013*

Mr. David Ochmanek, Deputy Assistant Secretary of Defense for Force Development, Office of the Secretary of Defense

Major General Timothy Ray (USAF), Director, Operational Planning, Policy and Strategy

Major General James McLaughlin (USAF), Commander, 24th Air Force and Commander, Air Forces Cyber, JB San Antonio–Lackland, Texas

*Arlington, Virginia, September 26, 2013*

General Charles H. Jacoby Jr. (USA), Commander, North American Aerospace Defense Command and U.S. Northern Command (via secure video teleconference)

*Arlington, Virginia, October 24, 2013*

Major General Brian Meenan (USAF), Mobilization Assistant to the Commander, Air Mobility Command, Scott AFB, Illinois and member of the Total Force Task Force (TF2)

Major General John Posner (USAF), Director of Global Power Programs, Office of the Assistant Secretary of the Air Force, Acquisition, Headquarters U.S. Air Force, and member of the Total Force Task Force (TF2)

Major General Mark Bartman (ANG), Assistant Adjutant General–Air, Ohio National Guard, and member of the Total Force Task Force (TF2)

*Arlington, Virginia, November 18–19, 2013*

The Honorable Eric Fanning, Acting Secretary of the U.S. Air Force  
General Mark A. Welsh III (USAF), Chief of Staff of the U.S. Air Force.

**TESTIMONY BEFORE THE COMMISSION (ALPHABETICAL)**

Mr. Michael Altomare, Chief, Force Division (J-8), The Joint Chiefs of Staff

Major General (Ret.) Rita Aragon (ANG), Secretary of the Veterans Administration of Oklahoma, Secretary of the Military, former Commander of the Oklahoma Air Guard

Major General Deborah Ashenhurst (ARNG), The Adjutant General of Ohio

Senior Master Sergeant Taunya Latrice Avery (USAF), Production Supervisor, 507th Aircraft Maintenance Squadron, Tinker AFB, Oklahoma

Senior Master Sergeant Joey Bailey (USAF), Superintendent, 605th Aircraft Maintenance Squadron, JB McGuire-Dix-Lakehurst, New Jersey

Major General Joseph G. Balskus, Military Assistant to the Deputy Chief of Staff for Strategic Plans and Programs (A8), Headquarters U.S. Air Force, Total Force Task Force (TF2) (twice)

Major General (Ret.) Jim Bankers (USAF), President, Department of Georgia, Reserve Officers Association

Major General Mark Bartman (ANG), Assistant Adjutant General–Air, Ohio National Guard, and member of the Total Force Task Force (TF2)

Lieutenant Colonel John Boccieri (USAF), Commander 773rd Air Squadron Assistance Squadron, 910th Airlift Wing, Youngstown ARS, Ohio

Brigadier General Robert C. Bolton (ANG), Commander, New Jersey Air National Guard

Lieutenant Colonel Kevin Buddelmeyer (USAF), Chief of Safety, 88th Air Base Wing, Wright-Patterson AFB, Ohio

General Bill Burks (ANG), The Adjutant General of Nevada

General James Campbell (ARNG), The Adjutant General of Maine

Chief Master Sergeant Raymond Carroll (ANG), 127th Civil Engineer Squadron, Selfridge ANGB, Michigan

Mr. Trey Carson, Principal Director (Resources), Office of the Assistant Secretary of Defense for Reserve Affairs

Lieutenant General Stanley E. Clarke III, Director, Air National Guard (twice)

Chief Master Sergeant James A. Cody (USAF), Chief Master Sergeant of the Air Force

Dr. Scott Comes, Acting Director, Cost Assessment and Program Evaluation (CAPE), Office of the Secretary of Defense (twice, first time as Deputy Director for Program Evaluation for CAPE)

Lieutenant Colonel Mike Cruff (USAF), Commander, 78th Air Refueling Squadron, 514th Air Mobility Wing, JB McGuire-Dix-Lakehurst, New Jersey

Major Robert Cunningham (ANG), Commander, 179th Maintenance Squadron, Mansfield Lahm ANGB, Ohio

Major Scott C. Czuba (USAF), Commander, 552nd Maintenance Squadron, 552nd Air Control Wing, Tinker AFB, Oklahoma

Mr. Michael Dalby, President and CEO of the Columbus Chamber of Commerce, former Air Force

Major General (Ret.) Andrew Davis (USMC), Executive Director, Reserve Officers Association of the United States

Major Christopher J. Davis (ANG), Commander, 137th Logistics Readiness Squadron, Will Rogers ANGB, Oklahoma

Colonel (Ret.) Robert Decker (ARNG), Chairman, Toledo Military Affairs Commission

Major General Myles Deering (ARNG), The Adjutant General of Oklahoma

Peter DeFluri, Director, Projection Forces Division, Cost Assessment and Program Evaluation, Office of the Secretary of Defense

Ms. Nino DePasquale, President, The Armed Forces Heritage House Museum

Ms. Lisa Disbrow, Vice Director, Force Structure, Resources, and Assessment (J-8), The Joint Chiefs of Staff

Mr. Michael Dominguez, Director of Strategy, Forces, and Resources Division, Institute for Defense Analyses

The Honorable Michael B. Donley, Secretary of the Air Force

Mr. Joseph Donnelly, Director, Burlington County Board of Chosen Freeholders

Dr. Colin Doyle, Research Staff Member, Institute for Defense Analyses

Ms. Nancy Dragani, Director, Ohio Emergency Management Agency



Mr. Peter Duffy, Director of Legislation, National Guard Association of the United States  
General Don Dunbar (ANG), The Adjutant General of Wisconsin, Chairman for Homeland Security and  
Emergency Response Committee  
Major General (Ret.) Tommy Dyches (USAF), Assistant to the Chairman of the Joint Chiefs of Staff for Reserve Matters  
Major General Howard M. “Mike” Edwards (ANG), The Adjutant General of Colorado  
Chief Master Sergeant Jeffrey Glenn Elders (ANG), Superintendent for Flight Line, 137th Air Refueling Wing,  
Will Rogers ANGB, Oklahoma  
Lieutenant Colonel Steven England (USAF), Director of Operations, 970th Airborne Air Control Squadron,  
Tinker AFB, Oklahoma  
The Honorable Mary Fallin, Governor of Oklahoma  
The Honorable Eric Fanning, Acting Secretary of the U.S. Air Force  
Brigadier General Gregory L. Ferguson (ANG), Assistant Adjutant General of Oklahoma  
General (Ret.) Ronald R. Fogleman (USAF), former Chief of Staff, U.S. Air Force  
Mr. Kurt Foreman, Executive Vice President of Economic Development, Greater Oklahoma City Chamber of Commerce  
Major General (Ret.) H.H. “Bugs” Forsythe (USAF), Mobilization Assistant to the Commander, 9th Air Force,  
Shaw AFB, South Carolina  
Ms. Christine Fox, Director, Cost Assessment and Program Evaluation  
Mr. Michael Francis, Staff Assistant, U.S. Congressman Frank LoBiondo of the 2nd Congressional District of New Jersey  
Ms. Jan Frantz, Executive Director, BC CAL KAL Inland Port Development Corporation  
Mayor Jack Fry, Mayor, Midwest City, Oklahoma  
Mr. Al Garver, Executive Director, Enlisted Association of the National Guard  
General Frank J. Grass (USA), Chief, National Guard Bureau  
Mr. Mark Gunzinger, Senior Fellow, Center for Strategic and Budgetary Assessments  
Mr. Philip Handelman, Historian, Selfridge Base Community Council  
Captain (Ret.) Marshall Hanson (USNR), Legislative Director, Reserve Officers Association of the United States  
Lieutenant Colonel Stephen Henske (ANG), Commander, 108th Force Support Squadron,  
JB McGuire-Dix-Lakehurst, New Jersey  
Mr. Jeffrey Hoagland, President and CEO, Dayton Development Coalition  
Ms. Heather Hogsett, Director, National Governors’ Association Health and Homeland Security Committee  
Dr. Stanley Horowitz, Assistant Division Director, Institute for Defense Analyses  
Chief Master Sergeant James W. Hotaling (ANG), Command Chief Master Sergeant, Air National Guard  
Lieutenant Colonel Michael Hrynciw (ANG), Operations Flight Commander, 200th Red Horse Squadron,  
Mansfield Lahm ANGB, Ohio  
Senator James Inhofe, Oklahoma  
Brigadier General Leonard Isabelle (ANG), Commander, Michigan Air National Guard  
Lieutenant General James F. “J.J.” Jackson (USAF), Chief, Air Force Reserve (three times)  
General Charles H. Jacoby Jr., Commander, North American Aerospace Defense Command and U.S. Northern Command  
(via secure video teleconference)  
The Honorable Deborah Lee James, Secretary of the Air Force  
Major Carl V. Jones III (USAF), Commander, 552nd Aircraft Maintenance Squadron, Tinker AFB, Oklahoma  
Lieutenant Colonel Eric Kaufman (ANG), 121st Air Refueling Wing, Rickenbacker ANGB, Ohio  
Captain Chris Kelenske, Deputy Director, Michigan State Police, was unable to attend but later submitted his statement as a  
public comment  
Major General (Ret.) Philip Killey (ANG), former Adjutant General of South Dakota and Director of the Air National Guard  
Chief Master Sergeant Cameron B. Kirksey (USAF), Command Chief Master Sergeant, Air Force Reserve

Mr. Thomas LaCrosse, Director of Defense Support of Civil Authorities, Office of the Assistant Secretary of Defense for Homeland Defense and America's Security Affairs

State Senator Frank LaRose, Senate District 27, Ohio

Lieutenant Colonel Constantine Leon (ANG), Commander, 127th Comptroller Flight, Selfridge ANGB, Michigan

Mr. Gerry P. Little, Director, Ocean County Board of Chosen Freeholders

Major General Robert E. Livingston, Jr. (ARNG), The Adjutant General of South Carolina

Major General Joe Logan (ANG), Commander, 200th Red Horse Squadron, Detachment 1, Mansfield Lahm ANGB, Ohio

Major General (Ret.) Andy Love (ANG), former Assistant to the Commander of USNORTHCOM for National Guard Matters

Chief Master Sergeant John Mazza (USAF), 88th Air Base Wing, Wright-Patterson AFB, Ohio

Lieutenant Colonel (Ret.) John McCance (USAF), Air Reserve Technician, Wright-Patterson AFB, Ohio

Mr. David McKeon, Planning Director, Ocean County, New Jersey

General (Ret.) Craig R. McKinley (ANG), President, Air Force Association

Major General James McLaughlin (USAF), Commander, 24th Air Force and Commander, Air Forces Cyber, JB San Antonio-Lackland, Texas

Major General Brian Meenan, Mobilization Assistant to the Commander, Air Mobility Command, Scott Air Force Base, Ill., and member of the Total Force Task Force (TF2) (twice)

Chief Master Sergeant Lisa Menser (USAF), Air Reserve Technician, Chief Enlisted Manager, 514th Maintenance Group, JB McGuire-Dix-Lakehurst, New Jersey

Lieutenant Brady Minich (ANG), Maintenance Operation Officer, 121st Air Refueling Wing, Rickenbacker ANGB, Ohio

Lieutenant Colonel Rob Mitrix (USAF), Commander, 89th Airlift Squadron, 445th Air Wing, Wright-Patterson AFB, Ohio

Lieutenant General Michael R. Moeller (USAF), Air Force Deputy Chief of Staff for Strategic Plans and Programs (A8), Headquarters U.S. Air Force

Senator Lisa Murkowski, Alaska

Mr. Lewis Nagy, Executive Director, Defense Enhancement Coalition

Lieutenant General (Ret.) Dick Newton (USAF), Executive Vice President, Air Force Association

Mr. David Ochmanek, Deputy Assistant Secretary of Defense for Force Development, Office of the Secretary of Defense

Major General Timothy Orr (ARNG), The Adjutant General of Iowa, representative to the Council of Governors (twice)

Ms. Mary Catherine Ott, Legislative Manager, Air Programs and Cyber Security, National Guard Association of the United States

Congressman Steve Palazzo, 4th Congressional District, Mississippi

Mr. Alan Parks, Garrison Manager, U.S. Army Garrison, Detroit Arsenal, was unable to attend but submitted a statement to the meeting

Mr. Paul Patrick, Deputy Assistant Secretary of Defense for Reserve Affairs (Readiness, Training, and Mobilization)

Brigadier General (Ret.) Mike Peplinski (ANG), former Commander, Selfridge ANGB, Michigan, on behalf of employers of the National Guard

State Representative Rick Perales, House District 73, Ohio

Major General (Ret.) Richard A. "Dick" Platt (ANG), former Assistant to the Director of the Air National Guard

Chief Master Sergeant Mark Poole (ANG), Operations Chief, 251st Alderson Reporting Company, Cyber Engineering Installation Group, Springfield ANGB, Ohio

Major General John Posner, Director of Global Power Programs, Office of the Assistant Secretary of the Air Force, Acquisition, Headquarters U.S. Air Force, and member of the Total Force Task Force (TF2) (twice)

Colonel Robert Preiss (ARNG), Chief of Staff and Senior Policy Advisor, Army National Guard

Lieutenant Colonel Alan L. Priest (USAF), Director of Maintenance, 513th Air Control Group, Tinker AFB, Oklahoma

Major General (Ret.) Arnold Punaro (USMC), Chairman of the Reserve Force's Policy Board but testifying in individual

capacity as a long serving military officer, congressional staff leader, and a member of a number of boards and commissions that have had an impact on the Department of Defense.

Major General Timothy Ray (USAF), Director, Operational Planning, Policy and Strategy

General William Reddel (ANG), The Adjutant General of New Hampshire

Chief Master Sergeant Troy Rhoades (USAF), Command Chief Master Sergeant, 910th Airlift Wing, Youngstown ARS, Ohio

Lieutenant Colonel Mitchell Richardson (USAF), Commander, 89th Airlift Squadron, Wright-Patterson AFB, Ohio

Dr. Albert Robbert, RAND, Senior Policy Researcher, former active duty Air Force

Major General Anthony J. Rock (USAF), Vice Director, Strategic Plans and Policy (J-5), The Joint Chiefs of Staff

Chief Master Sergeant Peri Rogawski (USAF), Command Chief, 444th Airlift Wing, Wright-Patterson AFB, Ohio

Mr. Todd Rosenblum, Acting Assistant Secretary of Defense for Homeland Defense and Americas' Security Affairs

Mr. Russell Rumbaugh, Director for Budgeting for Foreign Affairs and Defense, Senior Associate at the Stimson Center

Congressman Jon Runyan, 3rd Congressional District, New Jersey

Master Sergeant Steven Rybitski (USAF), Superintendent of Plans and Programs, 88th Security Forces Squadron,  
Wright-Patterson AFB, Ohio

Chief Master Sergeant Matt Sanders (USAF), 87th Civil Engineers Squadron, 87th Air Base Wing, JB McGuire-Dix-Lakehurst,  
New Jersey

Lieutenant Colonel Daniel Sarachene (USAF), Commander, 757th Airlift Squadron, 910th Air Wing, Youngstown ARS, Ohio

Master Sergeant Mike Schaefer (ANG), Recruiting Office Supervisor, 179th Airlift Wing, Mansfield Lahm ANGB, Ohio

Mr. Matthew Schaffer, Deputy Director, Analysis & Integration, Cost Assessment and Program Evaluation,  
Office of the Secretary of Defense

Dr. Joe Schwarz, Battle Creek Unlimited, former Member of Congress

Major General (Ret.) Frank Scoggins (ANG), former Assistant Adjutant General of the Washington National Guard

Colonel (Ret.) Rodger Seidel (ANG), former Commander, W.K. Kellogg ANGB, Michigan

Mr. Bill Servial, Chairman, Economic Development Corporation of Harrison Township

State Representative Mike Sheehy, House District 46, Ohio, former U.S. Army, Retired Adjutant General

Ms. Elaine Simmons, Director, Land Forces Division, Cost Assessment and Program Evaluation, Office of the Secretary of  
Defense Colonel Sean Southworth (ANG), Commander, 217th Air Operations Group, W.K. Kellogg ANGB, Michigan

General David Sprynczynatyk (ARNG), The Adjutant General of North Dakota and Director of Emergency  
Services for North Dakota

Mr. David Stapelkamp, Staff Assistant, U.S. Senator Robert Menendez

Brigadier General Mark Stephens (ANG), Director of Joint Staff, Ohio National Guard

Major General James N. Stewart (USAF), Director, Reserve Forces Policy Board (twice, second time presenting  
his personal views)

Major Mark Szatkowski (USAF), Commander, 305th Maintenance Squadron, 305th Air Mobility Wing,  
JB McGuire-Dix-Lakehurst, New Jersey

The Honorable Mary Taylor, Lieutenant Governor of the State of Ohio

Colonel Bryan Teff (ANG), Commander, Alpena Combat Readiness Training Center, Michigan

Colonel Michael T. Thomas (ANG), Commander, 127th Wing, Selfridge ANGB, Michigan

Major General Emmett R. "Buddy" Titshaw Jr. (ANG), The Adjutant General of Florida, Chair of the TAG's  
Committee on Air National Guard Force Structure and Modernization (twice)

Major General Edward Tonini (ANG), The Adjutant General of Kentucky

Major Philip Townsend (USAF), 757th Airlift Squadron, Youngstown ARS, Ohio

Lieutenant Colonel Matt Trumble (ANG), Director of Operations, Grayling Air Gunnery Range,  
Alpena Combat Readiness Training Center, Michigan

Major General Gregory J. Vadnais (ARNG), The Adjutant General for Michigan

Colonel Ralph J. Waite IV, USAF, Analyst, Tactical Air Forces Division, Cost Assessment and Program Evaluation, Office of the Secretary of Defense

The Honorable Matt Waligora, Mayor of Alpena, Michigan

Major General (Ret.) Paul Weaver (ANG), former Director of the Air National Guard

General Mark A. Welsh III (USAF), Chief of Staff of the U.S. Air Force (twice)

Lieutenant Colonel Joseph Wenckus (USAF), Commander, 21st Air Mobility Operations Squadron,  
621st Contingency Response Wing, JB McGuire-Dix-Lakehurst, New Jersey

State Senator Chris Widener, Senate District 10, Ohio

Mr. Richard O. Wightman, Principal Deputy Assistant Secretary of Defense for Reserve Affairs

Colonel (Ret.) Walker M. Williams, III (USAF), National President, Reserve Officers Association of the United States

Chief Master Sergeant Patrick Wilson (USAF), Superintendent, 552 Air Control Group, 552nd Air Control Wing,  
Tinker AFB, Oklahoma

Colonel Ronald W. Wilson (ANG), Commander, 110th Airlift Wing, W.K. Kellogg ANGB, Michigan

Major General William D. Wofford (ARNG), The Adjutant General of Arkansas and President,  
Adjutants General Association of the United States

Master Sergeant Paul Wong (ANG), 125th Intelligence Squadron, 178th Fighter Wing, Springfield ANGB, Ohio

Dr. F. Matthew Woodward, Analyst, Cost Assessment and Program Evaluation, Office of the Secretary of Defense

Mr. Ronald G. Young, Director (Family and Employer Programs and Policy), Office of the Assistant Secretary of Defense for Reserve Affairs

Colonel (Ret.) Joseph E. Zeis Jr. (USAF), Executive Vice President of the Dayton Development Coalition,  
Chair of the Ohio Air, Space, and Aviation Council

Chief Master Sergeant Stephen Zinner, Superintendent, 204th Intelligence Squadron, New Jersey Air National Guard



## APPENDIX H

# GLOSSARY OF TERMS AND ACRONYMS

## Glossary of Terms

### **ACTIVE ASSOCIATION**

An integration model that combines Active and Reserve elements, with the Reserve Component retaining principal responsibility for a weapon system and sharing the equipment with one or more Active Component units. Today, the Active and Reserve units retain separate organizational structures and chains of command.

### **ACTIVE COMPONENT (AC)**

The unrestricted, continuously available personnel, units, and equipment of the Air Force. 10 U.S.C. §8075 calls this component the Regular Air Force, but generally the services use the term *Active*.

### **ACTIVE DUTY**

Full-time duty in the active military service, including members of the Reserve Component serving on active duty or full-time training duty (but not including full-time National Guard duty serving the state).

### **ACTIVE GUARD AND RESERVE (AGR)**

National Guard and Reserve members who are on active duty providing full-time support to National Guard, Reserve, and Active Component organizations for the purpose of organizing, administering, recruiting, instructing, or training the Reserve Component.

### **AIR RESERVE COMPONENT (ARC)**

The forces of the Air National Guard and Air Force Reserve.

### **AIR RESERVE COMPONENT (ARC) ASSOCIATION**

An integration model that combines two Reserve Component elements, with one retaining principal responsibility for a weapon system and sharing the equipment with one or more of the other component's units. Today, the units retain separate organizational structures and chains of command.

### **CAPABILITY**

The ability to maintain the necessary level and duration of operational activity to achieve military objectives. Entails force structure, modernization, readiness, and sustainability.

### **CAPACITY**

The force structure required to meet a single or multiple military objectives.

### **CLASSIC ASSOCIATION**

An integration model that combines Active and Reserve elements, with the Active Component retaining principal responsibility for a weapon system and sharing the equipment with one or more Reserve Component units. Today, the Active and Reserve units retain separate organizational structures and chains of command.

### **COMPLEX CATASTROPHE**

The Department of Defense defines a complex catastrophe as a natural or man-made incident, including cyberspace attack, power grid failure, and terrorism, which results in cascading failures of multiple interdependent, critical, life-sustaining

infrastructure sectors and causes extraordinary levels of mass casualties, damage, or disruption severely affecting the population, environment, economy, public health, national morale, response efforts, or government functions.

### **CONTINUUM OF SERVICE**

A concept that removes or mitigates legal, procedural, and cultural barriers for personnel to transition among different components over the course of a career without derailing their professional advancement while also maximizing the service's investment in that individual.

### **DEFENSE PLANNING SCENARIOS (DPS)**

Secretary of Defense-approved depictions of threats to international security, corresponding missions for U.S. military forces, and strategic-level concepts of operation for carrying out these missions. Services use DPS as a starting point for analyses supporting planning, programming, and acquisition efforts.

### **DEFENSE SUPPORT OF CIVIL AUTHORITIES (DSCA)**

Support provided by the Department of Defense, including the National Guard and other U.S. federal military forces, in response to requests from civil authorities for assistance with domestic emergencies, law enforcement support, and other domestic activities, or from qualifying entities for special events. National Guard forces may be utilized when the Secretary of Defense

in coordination with the Governors of the affected states, elects and requests to use those forces under Title 32.

### **DEPLOY-TO-DWELL**

Ratio of time Active Component military organizations spend deployed compared to the amount of time they spend not deployed. Thus, 1:2 means that for the period deployed the organization would spend two periods at home. (For Reserve Component forces, see Mobilization-to-Dwell.)

### **DESIGNED OPERATIONAL CAPABILITY (DOC)**

The mission for which a measured unit has been equipped, organized, or designed. A measured unit is an Active, Reserve, or Air Guard unit with a descriptor code indicating combat, combat support, or combat service support.

### **DRILL STATUS GUARDSMAN**

A member of the National Guard who drills one weekend per month and 15 days per year. A drill status Guardsman may be called upon by the Governor in the event of a natural or manmade disaster (under state active duty or, if approved by the Secretary of Defense, under U.S. Code Title 32), and may be activated by the President for federal duty (under U.S. Code Title 10).

### **DUAL STATUS COMMANDER (DSC)**

A commander who may, by law, serve in two statuses, federal and state, simultaneously. In state status, the DSC is a member of the state chain of command, subject to the orders of the Governor and Adjutant General of the DSC's state, and, on their behalf, exercises command of assigned state National Guard forces. At the same time, the DSC exercises command of assigned federal forces on behalf of the President through a chain of command established by a combatant commander. Both the President and Governor must consent to the dual status.

### **DUAL STATUS MILITARY TECHNICIAN**

A Reserve Component member who serves in a position as both a full-time federal civil service employee and as a traditional Reservist. Generally, during the week, the technician receives civilian compensation, but during drill periods and annual training receives military compensation. Such full-time employees serve in organizing, administering, instructing, or training of the Selected Reserve or in the maintenance and repair of supplies and equipment. The Air Force Reserve Command refers to these personnel as Air Reserve Technicians or ARTs.

### **DWELL**

For the Active Component, dwell is the period between mandatory deployments. For the Reserve Component, dwell is the period between the release from involuntary active duty and the reporting date for a subsequent tour of involuntary active duty. For the Reserve Component, dwell includes any voluntary active duty performed between the two periods of involuntary active duty, and may include any Individual Skill Training Required for Deployment and Post-Mobilization Leave that has been excluded by the Secretary of Defense from counting against the 12-month mobilization period.

### **END STRENGTH**

The number of personnel authorized by legislation for a given fiscal year.

### **FORCE STRUCTURE**

The military service's interconnected framework—Active, Reserve and Guard components, equipment, personnel, and real estate—that exists to accomplish specific missions in support of the President and the Secretary of Defense.

### **"FULL-TIME" FORCES**

A member of the Active Component, an Active Guard and Reserve member, or a Dual Status Military Technician. (See also "Part-Time" Forces.)

### **HIGH-DEMAND, LOW-DENSITY ASSET**

A combat, combat support, or service support capability, unit, system, or occupational specialty that the Secretary of Defense determines has funding, equipment, or personnel levels that are substantially below the levels required to fully meet or sustain actual or expected operational requirements set by regional commanders

### **HOLLOW FORCE**

Military forces that appear mission-ready but, upon examination, suffer from shortages of personnel, equipment, and maintenance or from deficiencies in training.

### **HOMELAND DEFENSE**

The protection of U.S. sovereignty, territory, domestic population, and critical infrastructure against external threats or aggression or other threats as identified by the President.

### **HOMELAND SECURITY**

A concerted national effort to prevent terrorist attacks within the United States; reduce America's vulnerability to terrorism, major disasters, and other emergencies; and minimize the damage and recover from attacks, major disasters, and other emergencies that occur.

### **INDIVIDUAL MOBILIZATION AUGMENTEE (IMA)**

Traditional members of the Air Force Reserve assigned to an Active Component, Selective Service System, or Federal Emergency Management Agency organization's billet. IMAs drill and deploy with that Active unit. An individual Reservist attending drills who receives training and is

pre-assigned to an Active Component organization, a Selective Service System, or a Federal Emergency Management Agency billet that must be filled on, or shortly after, mobilization. IMAs train on a part-time basis with these organizations to prepare for mobilization. Inactive duty training for IMAs is decided by component policy and can vary from zero to 48 drills a year.

### **INDIVIDUAL READY RESERVE (IRR)**

A manpower pool consisting of individuals who have had some training or who have served previously in the Active Component or in the Selected Reserve and may have some period of their military service obligation remaining. Members may voluntarily participate in training for retirement points and promotion with or without pay.

### **INTEGRATED WING (I-WING)**

An integration model that combines Active and Reserve elements within one organizational structure and chain of command, with members of all components contributing to a common unit mission.

### **LIFE-CYCLE COSTS**

(1) The total cost of a piece of equipment from its development, fielding, and sustainment through retirement. (2) The total cost of an Airman in service to the nation, from entry into service through death, including the costs of training, service, and benefits.

### **MAN-DAY**

Military funding paid to Reservists to perform duty over and above their minimum number of days for inactive duty training and annual tour. Each Man-Day pays the member one day's base pay, housing allowance, subsistence allowance, and other appropriate military pay entitlements.

### **MILITARY PERSONNEL APPROPRIATION (MPA)**

Active Component military funding paid to Reservists to support the short-term needs of the Active force. Each Man-Day pays the member one day's base pay, housing allowance, subsistence allowance, and other appropriate military pay entitlements.

### **MOBILIZATION-TO-DWELL**

Ratio of time Reserve Component organizations or individuals spend mobilized for active duty compared to the amount of time they spend in a ready reserve state. Thus, 1:5 means that for each period mobilized the organization or individual would spend five periods at home.

### **MODERNIZATION**

Updating an existing system to improve operational capability or technical performance.

### **NATIONAL MILITARY STRATEGY (NMS)**

A document approved by the Chairman of the Joint Chiefs of Staff for distributing and applying military power to attain national security strategy and national defense strategy objectives.

### **NATIONAL SECURITY STRATEGY (NSS)**

A document approved by the President of the United States for developing, applying, and coordinating the instruments of national power to achieve objectives that contribute to national security.

### **OPERATING TEMPO (OPTEMPO)**

A measure of the pace of an operation or operations in terms of equipment usage. For example, the Air Force measures aircraft flying hours to gauge OPTEMPO.

### **OPERATIONAL RESERVE**

A term used to describe the current situation in which the Air Force holds Reserve Component forces to the same standards of readiness as the Active Component, and regularly rotates these forces onto active duty service, whether in times of war or in peacetime. Joint Publication (JP) 5-0 defines Operational Reserve as an "emergency reserve of men and/or materiel established for the support of a specific operation."

### **"PART-TIME" FORCES**

Forces comprised primarily of traditional Reservists or drill status Guardsmen. The Commission recognizes that most, if not all, traditional Guardsmen and Reservists in the Air Force dedicate themselves fully to their service's core principles and ideals. This report uses this term only to differentiate the pay status of those not on full-time active duty.

### **PERSONNEL TEMPO (PERSTEMPO)**

The time an individual spends away from home station, whether for deployment, unit training events, special operations and exercises, or mission support temporary duty.

### **RAINBOWING**

When personnel and aircraft from more than one unit combine to form one designated unit in order to meet the requirements of an Air Expeditionary Force,

### **READINESS**

The ability of a military unit to respond to and meet the demands of missions assigned in its Designed Operational Capability statement.

### **READY RESERVE**

Individuals and units liable for active duty. This includes the Selected Reserve, Individual Ready Reserve, and inactive National Guard.

**RECAPITALIZATION**

Replacing an existing weapon system with another weapon system. Frequently, the new weapon system is more modern than the existing weapon system.

**RESERVE PERSONNEL APPROPRIATION (RPA)**

That portion of the Military Personnel Appropriation designated to pay Reserve and Guard members, including drill and training pay and allowances.

**SELECTED RESERVE**

Those units and individuals within the Ready Reserve designated by their respective Services and approved by the Joint Chiefs of Staff as so essential to initial wartime missions that they have priority over all other Reserves.

Selected Reservists actively participate in a Reserve Component training program. The Selected Reserve also includes persons performing initial active duty for training.

**STRATEGIC RESERVE**

A Reserve force intended for use during later stages of a protracted or large-scale operation but not on a day-to-day basis.

**SURGE**

A rapid or concerted increase in the commitment of forces to fend off an attack, meet a sudden demand, or accomplish a strategic military objective.

**TOTAL FORCE**

All U.S. Air Force organizations, units, and individuals—Active, Reserve,

Guard, and civilian—that provide the capabilities to support the Department of Defense in implementing the national security strategy.

**TRADITIONAL RESERVIST**

A member of the Air Force Reserve who drills one weekend per month and two weeks per year. A traditional Reservist may be activated for contingency operations or extended assignments.

**WARM BASE**

An installation or part of an installation without permanent operational forces; such installations are maintained at a level that will allow rapid re-occupation by operational forces.



## Glossary of Acronyms

<b>1st Lt</b>	First Lieutenant	<b>AFTOC</b>	Air Force Total Ownership Cost	<b>AW</b>	Airlift Wing
<b>2nd Lt</b>	Second Lieutenant	<b>AGR</b>	Active Guard and Reserve	<b>AWACS</b>	Airborne Warning and Control System
<b>A-10</b>	Fairchild Republic A-10 Thunderbolt II, a twin-engine close-air support attack jet aircraft	<b>ALS</b>	Airman Leadership School	<b>B-1</b>	Rockwell B-1 Lancer, a four-engine jet supersonic variable-sweep wing bomber
<b>A1C</b>	Airman First Class	<b>AMC</b>	Air Mobility Command	<b>B-2</b>	Northrop Grumman B-2 Spirit, a wing-shaped stealth bomber
<b>ABU</b>	Airman Battle Uniform	<b>AMDS</b>	Aerospace Medicine Squadron	<b>B-52</b>	Boeing B-52 Stratofortress, an eight-engine jet bomber aircraft
<b>AC</b>	Active Component	<b>Amn</b>	Airman	<b>BAH</b>	Basic Allowance for Housing
<b>ACC</b>	Air Combat Command	<b>ANG</b>	Air National Guard	<b>BAS</b>	Basic Allowance for Subsistence
<b>ACO</b>	Airspace Control Order	<b>ANGB</b>	Air National Guard Base	<b>BOG</b>	Boots on the Ground—number of days at deployment location
<b>ACS</b>	Agile Combat Support	<b>ANGS</b>	Air National Guard Station	<b>BOS</b>	Base Operations Support
<b>ACSC</b>	Air Command and Staff College	<b>AOC</b>	Air Operations Center	<b>BRAC</b>	Base Realignment and Closure
<b>ADAG</b>	Aircraft Design and Aeroflight Dynamics Group	<b>AOG</b>	Air Operations Group	<b>Brig Gen</b>	Brigadier General
<b>ADCON</b>	Administrative Control	<b>AOR</b>	Area of Responsibility	<b>BS</b>	Bomb Squadron
<b>A SUPT DSW</b>	Active Duty for Special Work	<b>APS</b>	Aerial Port Squadron	<b>BW</b>	Bomb Wing
<b>AEF</b>	Air Expeditionary Force	<b>AR</b>	Air Refueling	<b>BX</b>	Base Exchange
<b>AETC</b>	Air Education and Training Command (formerly ATC)	<b>ARB</b>	Air Reserve Base	<b>C2</b>	Command and Control
<b>AFA</b>	Air Force Association	<b>ARC</b>	Air Reserve Component	<b>C4ISR</b>	Command, Control, Communications, Computers, Intelligence, Surveillance, and Reconnaissance
<b>AFB</b>	Air Force Base	<b>ARS</b>	Air Reserve Station; Air Refueling Squadron	<b>C-5</b>	Lockheed C-5 Galaxy, a large four-engine jet military transport aircraft
<b>AFGSC</b>	Air Force Global Strike Command	<b>ART</b>	Air Reserve Technician	<b>C-17</b>	Boeing C-17 Globemaster III, a four-engine jet military transport aircraft
<b>AFIPPS</b>	Air Force Integrated Personnel and Pay System	<b>ARW</b>	Air Refueling Wing	<b>C-23</b>	Short C-23 Sherpa, a small two-engine propeller transport aircraft
<b>AFRC</b>	Air Force Reserve Command	<b>AS</b>	Airlift Squadron		
<b>AFSC</b>	Air Force Specialty Codes	<b>ASD</b>	Assistant Secretary of Defense		
<b>AFSPC</b>	Air Force Space Command	<b>ASD HD/ASA</b>	Assistant Secretary of Defense for Homeland Defense and America's Security Affairs		
<b>AFFOR</b>	Air Force forces	<b>ASOC</b>	Air Support Operations Center		
<b>AFMC</b>	Air Force Materiel Command	<b>AT</b>	Antiterrorism		
		<b>ATC</b>	Air Traffic Control		
		<b>ATO</b>	Air Tasking Order		
		<b>ATP</b>	Air Transport Pilot Rating (an FAA term)		

<b>C-26</b>	Fairchild C-26 Metroliner, a twin-turboprop electronic surveillance aircraft	<b>CSAF</b>	Chief of Staff of the Air Force	<b>F-15</b>	McDonnell Douglas F-15 Eagle, a twin-engine jet fighter
<b>C-27</b>	Alenia C-27 Spartan, a twin-engine turboprop military transport aircraft	<b>CSAR</b>	Combat Search and Rescue	<b>F-16</b>	General Dynamics F-16 Fighting Falcon, a single-engine jet fighter
<b>C-130</b>	Lockheed C-130 Hercules, a four-engine turboprop military transport aircraft	<b>CV</b>	Vice Commander	<b>F-22</b>	Lockheed Martin F-22 Raptor, a twin-engine jet multirole fighter
<b>C2P</b>	Command and Control Protection	<b>CVT</b>	Criticality-Vulnerability-Threat	<b>F-35</b>	Lockheed Martin F-35 Lightning II, a single-engine jet multirole fighter
<b>CAF</b>	Combat Air Forces	<b>DCA</b>	Defense Communications Agency; Defense Cooperation Agreements; defensive counterair; dual-capable aircraft	<b>FAA</b>	Federal Aviation Administration
<b>CAPE</b>	Cost Assessment and Program Evaluation	<b>DCAPES</b>	Deliberate and Crisis Action Planning and Execution Segments	<b>FACA</b>	Federal Advisory Committee Act
<b>Capt</b>	Captain	<b>DeCA</b>	Defense Commissary Agency	<b>FCOM</b>	Flight Crew Operations Manual
<b>CAS</b>	Close Air Support	<b>DEERS</b>	Defense Enrollment Eligibility Reporting System.	<b>FEMA</b>	Federal Emergency Management Agency
<b>CBCS</b>	Combat Communications Squadron	<b>DFO</b>	Designated Federal Officer	<b>FFRDC</b>	Federally Funded Research and Development Center
<b>CBRNE</b>	Chemical, Biological, Radiological, Nuclear, and High-Yield Explosives	<b>DMAG</b>	Deputy's Management Advisory Group	<b>FGC</b>	Flight Guidance Computer
<b>CBT</b>	Computer-Based Training	<b>DMDC</b>	Defense Manpower Data Center	<b>FS</b>	Fighter Squadron
<b>CC</b>	Commander	<b>DOC</b>	Designed Operational Capability	<b>FSS</b>	Force Support Squadron
<b>CCDR</b>	Combatant Commander	<b>DoD</b>	Department of Defense	<b>FTU</b>	Formal Training Unit
<b>CE</b>	Civil Engineer	<b>DPS</b>	Defense Planning Scenarios	<b>FW</b>	Fighter Wing
<b>CES</b>	Civil Engineer Squadron	<b>DSCA</b>	Defense Support to Civil Authorities	<b>FY</b>	Fiscal Year (October 1 to September 30 for the U.S. Government)
<b>CFACC</b>	Combined Forces Air Component Commander	<b>DSN</b>	Defense Switched Network	<b>FYDP</b>	Future Years Defense Program
<b>CMAS</b>	Command Military Allocation System	<b>DTAC</b>	Defensive Tactics	<b>Gen</b>	General
<b>CMSAF</b>	Chief Master Sergeant of the Air Force	<b>EADS</b>	Eastern Air Defense Sector	<b>GIISR</b>	Global Integrated Intelligence, Surveillance, and Reconnaissance
<b>CMSgt</b>	Chief Master Sergeant	<b>ECM</b>	Electronic Counter Measure	<b>GMD</b>	Group Manning Document
<b>C-NAF</b>	Component Numbered Air Force	<b>EMAC</b>	Emergency Management Assistance Compact	<b>HAF</b>	Headquarters Air Force
<b>Col</b>	Colonel	<b>EOD</b>	Explosive Ordnance Disposal	<b>HUMINT</b>	Human Intelligence
<b>CONUS</b>	Continental United States	<b>ESGR</b>	Employer Support Group for the Guard and Reserve	<b>ICAM</b>	Individual Cost Assessment Model
<b>CRTC</b>	Combat Readiness Training Center	<b>EW</b>	Electronic Warfare	<b>ICBM</b>	Intercontinental Ballistic Missile
<b>CS</b>	Communications Squadron	<b>F-4</b>	McDonnell Douglas F-4 Phantom II, a two-seat, twin-engine jet fighter		

<b>IDA</b>	Institute for Defense Analyses	<b>MAF</b>	Mobility Air Forces	<b>NMS</b>	National Military Strategy
<b>IDT</b>	Inactive Duty Training; Individual Drill Training	<b>Maj</b>	Major	<b>NORAD</b>	North American Aerospace Defense Command
<b>IG</b>	Inspector General	<b>Maj Gen</b>	Major General	<b>NSS</b>	National Security Strategy
<b>IMA</b>	Individual Mobilization Augmentee	<b>MAJCOM</b>	Major Command	<b>O&amp;M</b>	Operations and Maintenance
<b>IO</b>	Information Operations	<b>MAP</b>	Military Assistance Program	<b>OCO</b>	Overseas Contingency Operations
<b>IP</b>	Instructor Pilot	<b>MC-12</b>	Medium to low altitude twin-turboprop ISR aircraft	<b>OCONUS</b>	Outside the Continental United States
<b>IS</b>	Intelligence Squadron	<b>MEOC</b>	Mobile Emergency Operation Center	<b>OEF</b>	Operation Enduring Freedom
<b>ISR</b>	Intelligence, Surveillance, and Reconnaissance	<b>MILCON</b>	Military Construction	<b>OG</b>	Operations Group
<b>JB MDL</b>	Joint Base McGuire-Dix-Lakehurst	<b>MLR</b>	Management Level Review	<b>OIF</b>	Operation Iraqi Freedom
<b>JFACC</b>	Joint Forces Air Component Commander	<b>MOB</b>	Mobilization	<b>OMLT</b>	Operational Mentor and Liaison Team
<b>JMD</b>	Joint Manning Document	<b>MOS</b>	Maintenance Operations Squadron	<b>OPCON</b>	Operational Control
<b>JOA</b>	Joint Operations Area	<b>MPA</b>	Military Personnel Appropriation	<b>OPR</b>	Office of Primary Responsibility; Officer Performance Report
<b>JP</b>	Joint Publication	<b>MPF</b>	Military Personnel Flight	<b>OPSEC</b>	Operations Security
<b>JROC</b>	Joint Requirements Oversight Council	<b>MQ-1</b>	General Atomics MQ-1 Predator, a remotely piloted aircraft	<b>OPTEMP</b>	Operating Tempo
<b>J-STARS</b>	Joint Surveillance Target Attack Radar System	<b>MQ-9</b>	General Atomics MQ-9 Reaper, a remotely piloted aircraft	<b>OSD</b>	Office of the Secretary of Defense
<b>JTAC</b>	Joint Terminal Air Controller	<b>MSG</b>	Mission Support Group	<b>OSS</b>	Operations Support Squadron
<b>KC-10</b>	McDonnell Douglas K-10 Extender, a three-engine jet military transport and aerial refueling aircraft	<b>MSgt</b>	Master Sergeant	<b>OT&amp;E</b>	Operational Test and Evaluation; Organize, Train, and Equip
<b>KC-46</b>	Boeing KC-46, a military aerial refueling and transport jet aircraft based on the 767 jet airliner	<b>MSS</b>	Mission Support Squadron	<b>OTS</b>	Officer Training School
<b>KC-135</b>	Boeing K-135 Stratotanker; four-engine jet military aerial refueling aircraft	<b>MWR</b>	Morale, Welfare, and Recreation	<b>PAA</b>	Primary Assigned Aircraft
<b>LIMFAC</b>	limiting factor	<b>MXG</b>	Maintenance Group	<b>PACAF</b>	Pacific Air Force
<b>LOX</b>	Liquid Oxygen	<b>NAF</b>	Numbered Air Force	<b>PCS</b>	Permanent Change of Station
<b>LRS</b>	Logistics Readiness Squadron	<b>NCSAF</b>	National Commission on the Structure of the Air Force	<b>PERSTEMPO</b>	Personnel Tempo
<b>Lt Col</b>	Lieutenant Colonel	<b>NCO</b>	Non-Commissioned Officer	<b>PJ</b>	Pararescue
<b>Lt Gen</b>	Lieutenant General	<b>NCOA</b>	Non-Commissioned Officer Academy	<b>PMAI</b>	Primary Mission Aircraft Inventory
		<b>NDO</b>	Nuclear Deterrence Operations	<b>PME</b>	Professional Military Education
		<b>NGAUS</b>	National Guard Association of the United States	<b>POL</b>	Petroleum, Oil, and Lubricants
		<b>NGB</b>	National Guard Bureau		

<b>POM</b>	Program Objectives Memorandum	<b>SFS</b>	Security Forces Squadron	<b>U-2</b>	Lockheed U-2 Dragon Lady, a single-engine, high-flying reconnaissance aircraft
<b>POTUS</b>	President of the United States	<b>SLEP</b>	Service Life Extension Program	<b>UCI</b>	Unit Compliance Inspection
<b>PPBE</b>	Planning, Programming, Budgeting, and Execution	<b>SMSgt</b>	Senior Master Sergeant	<b>UPT</b>	Undergraduate Pilot Training
<b>PRP</b>	Personnel Reliability Program	<b>SOCOM</b>	Special Operations Command	<b>USAF</b>	United States Air Force
<b>QRMC</b>	Quadrennial Review of Military Compensation	<b>SOPS</b>	Space Operations Squadron	<b>USAFA</b>	U.S. Air Force Academy
<b>RC</b>	Reserve Component	<b>SOS</b>	Squadron Officer School	<b>USAFE</b>	U.S. Air Forces Europe
<b>RDT&amp;E</b>	Research, Development, Test & Evaluation	<b>SOW</b>	Special Operations Wing	<b>USAFRICOM</b>	U.S. Africa Command
<b>REA</b>	Reserve Enlisted Association	<b>SPO</b>	Specialty Program Office	<b>USCENTCOM</b>	U.S. Central Command
<b>RED HORSE</b>	Rapid Engineer Deployable Heavy Operational Repair Squadron Engineers	<b>SrA</b>	Senior Airman	<b>USD(P&amp;R)</b>	Under Secretary of Defense for Personnel and Readiness
<b>RFF</b>	Request for Forces	<b>SSgt</b>	Staff Sergeant	<b>USERRA</b>	Uniformed Services Employment and Reemployment Rights Act
<b>RFPB</b>	Reserve Forces Policy Board	<b>STS</b>	Special Tactics Squadron	<b>USEUCOM</b>	U.S. European Command
<b>RIF</b>	Reduction in Force	<b>STU</b>	Secure Telephone Unit	<b>USNORTHCOM</b>	U.S. Northern Command
<b>ROA</b>	Reserve Officers Association	<b>SUPT</b>	Specialized Undergraduate Pilot Training	<b>USPACOM</b>	U.S. Pacific Command
<b>ROTC</b>	Reserve Officers' Training Corps	<b>SVTC</b>	Secure Video Telephone Conference	<b>USSOUTHCOM</b>	U.S. Southern Command
<b>RPA</b>	Remotely Piloted Aircraft	<b>SW</b>	Space Wing	<b>USSOCOM</b>	U.S. Special Operations Command
<b>RQ-4</b>	Northrop Grumman RQ-4 Global Hawk, a remotely piloted aircraft	<b>T-38</b>	Northrop T-38 Talon, two-seat, twin-engine jet trainer	<b>USTRATCOM</b>	U.S. Strategic Command
<b>RQ-170</b>	Lockheed Martin RQ-170 Sentinel, a remotely piloted aircraft	<b>TACAIR</b>	Tactical Air	<b>USTRANSCOM</b>	U.S. Transportation Command
<b>RQS</b>	Rescue Squadron	<b>TACON</b>	Tactical Control	<b>UTA</b>	Unit Training Assembly
<b>RQW</b>	Rescue Wing	<b>TAG</b>	The Adjutant General	<b>UTC</b>	Unit Type Code
<b>SAD</b>	State Active Duty	<b>TDY</b>	Temporary Duty	<b>vPCGR</b>	Virtual Personnel Center Guard Reserve
<b>SAM</b>	Surface to Air Missile	<b>TFI</b>	Total Force Integration	<b>WADS</b>	Western Air Defense Sector
<b>SAR</b>	Search and Rescue	<b>TO</b>	Technical Order	<b>WG</b>	Wing
<b>SCMR</b>	Strategic Choices and Management Review	<b>TOA</b>	Total Obligational Authority		
<b>SDP</b>	Strategic Distribution Platform	<b>TR</b>	Traditional Reservist		
<b>SECAF</b>	Secretary of the Air Force	<b>TRW</b>	Training Wing		
		<b>TSgt</b>	Technical Sergeant		
		<b>TTHS</b>	Trainees, Transients, Holdees, and Students		
		<b>TTP</b>	Tactics, Techniques, and Procedures		
		<b>T-X</b>	Designation for a two-seat fast jet trainer under development		



## APPENDIX I: RESOURCE CHAPTER CHARTS

FIGURE 5: **Spending Cycle**

AF Outlays in Millions of Constant 2014 Dollars

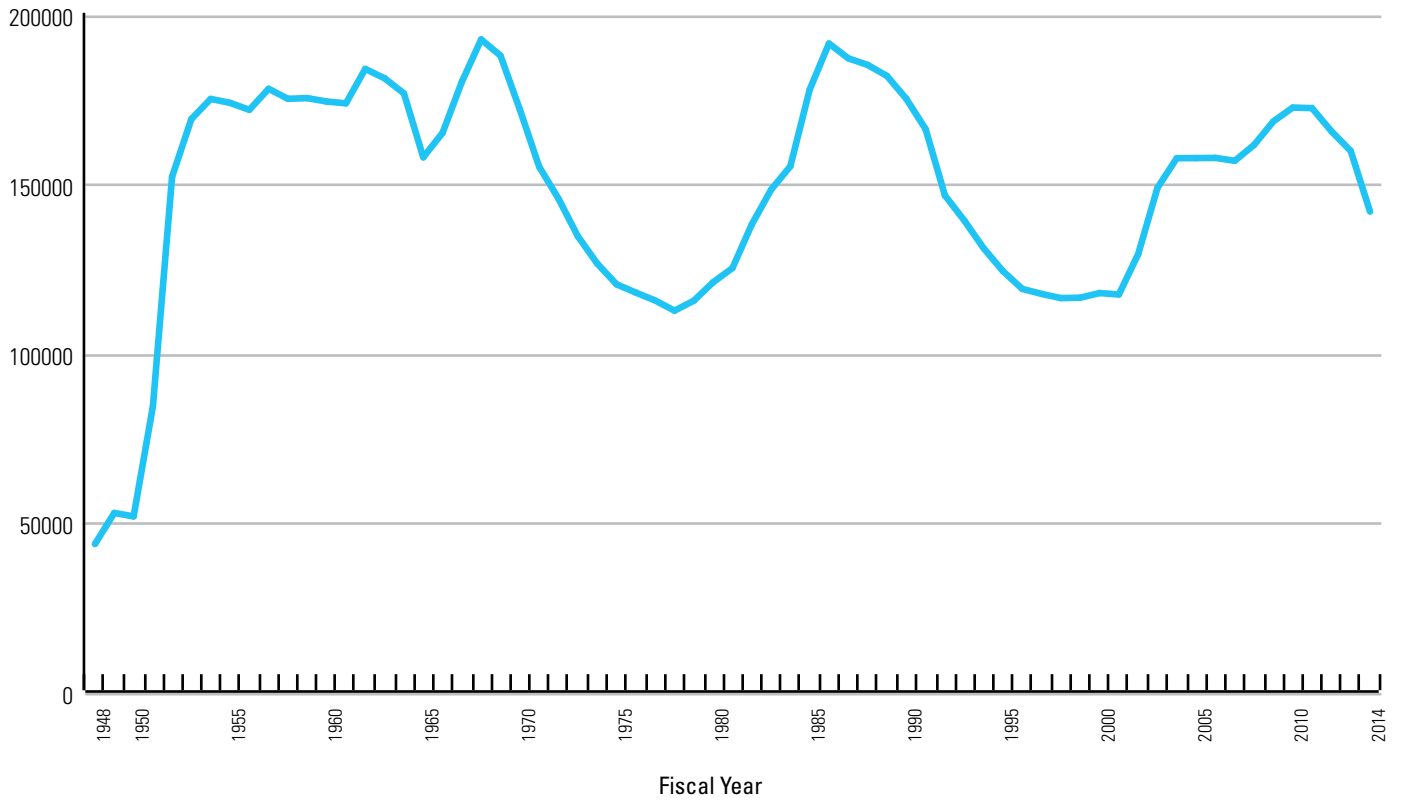
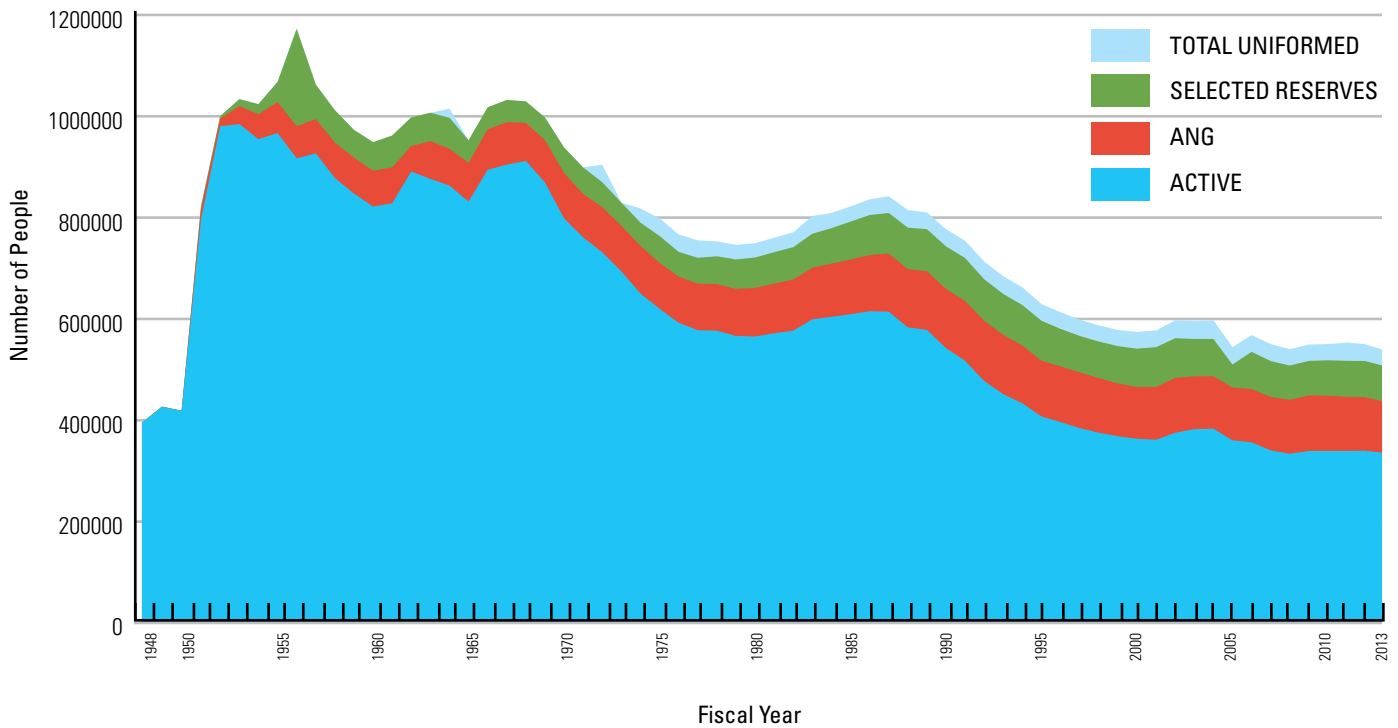


FIGURE 6: **Air Force End Strength**



## APPENDIX J

# SELECTED STATUTES AND POLICIES

### Command Structure and Headquarters

#### STATUTES

##### 10 U.S.C. §175—Reserve Forces Policy Board.

- Establishes the Reserve Forces Policy Board.
- See also 10 U.S.C. §10301 for functions, membership, and organization of the Reserve Forces Policy Board.

##### 10 U.S.C. §10174—Air Force Reserve Command (AFRC).

- Subsection (a) establishes the AFRC as a separate command of the Air Force.
- Subsection (b) establishes the Chief of Air Force Reserve as also holding the position of Commander of the AFRC.
- Subsection (c)(1) requires Secretary of the Air Force to assign to the AFRC all Air Force Reserve forces stationed in CONUS except those assigned to the Combatant Commanders for special operations forces.

##### 10 U.S.C. §10201—Assistant Secretary of Defense for Reserve Affairs.

- In accordance with 10 U.S.C. § 138(b)(2), the Assistant Secretary of Defense for Reserve Affairs is the DoD official with responsibility for the supervision of Reserve Component affairs.

##### 10 U.S.C. §10203—Reserve affairs: designation of general or flag officer of each armed force.

- Permits Secretary of the Air Force to designate an Air Force general officer to be directly responsible for reserve affairs to the Chief of Staff of the Air Force.

##### 10 U.S.C. §8038—Office of the Air Force Reserve: appointment of Chief.

- Subsection (a) establishes an Office of the Air Force Reserve within the Department of the Air Force. Subsection (a) also establishes that Office of Air Force Reserve is headed by a chief who is the adviser to the Chief of Staff on Air Force Reserve matters.
- Subsection (b) requires the President to appoint, with advice and consent of the Senate, the Chief of Air Force Reserve from AFR general officers with at least

10 years of commissioned service in the Air Force.

- Subsection (c)(1) permits the Chief of the Air Force Reserve to be appointed for a period of four years with a potential reappointment for an additional four-year period.
- Subsection (c)(2) permits the Chief of the Air Force Reserve to hold the grade of lieutenant general.
- 10 U.S.C. §10211—Policies and regulations: participation of Reserve officers in preparation and administration.
- Each armed force shall have officers of its Reserve Components on active duty (except for training) at the seat of government and at headquarters responsible for Reserve affairs. The statutory purpose is to participate in preparing and administering the policies and regulations affecting the Reserve Component.

##### 10 U.S.C. §10301—Reserve Forces Policy Board.

- Establishes the Reserve Forces Policy Board within the Office of the Secretary of Defense.
- Sets forth membership and organization requirements as well as matters within the Board's purview.

##### 10 U.S.C. §10305—Air Force Reserve Forces Policy Committee.

- Establishes the Air Reserve Forces Policy Committee within the Office of the Secretary of the Air Force.
- Sets forth organization of the Committee and general matters within its purview.

##### 10 U.S.C. §10501—National Guard Bureau.

- Establishes the National Guard Bureau within the Department of Defense.
- Sets forth the purposes of the National Guard Bureau.

##### 10 U.S.C. §10502—Chief of the National Guard Bureau: appointment; adviser on National Guard matters; grade; succession.

- Establishes appointment process and requirements for the Chief of the National Guard Bureau.
- Also establishes duties of the Chief of the National Guard Bureau.

**10 U.S.C. §10503—Functions of National Guard Bureau: charter.**

- Requires the creation of the National Guard Bureau charter to set forth the full scope of the duties and activities of the Bureau.
- Delineates matters within the scope of the duties and activities of the Bureau.

**10 U.S.C. §10507—National Guard Bureau: assignment of officers of Active or Reserve Components.**

- Permits the President of the United States to assign to duty in the Bureau as many Active or Reserve officers of the Army or Air Force as considered necessary.

**AIR FORCE INSTRUCTIONS****AFI 10-205—Availability of key headquarters Air Force personnel and Major Command Commanders. September 27, 2010.**

- Requires Headquarters, U.S. Air Force (HQ USAF) key personnel and major command (MAJCOM) commanders to keep HQ USAF informed of their location and identify any designated alternates when leaving his or her permanent duty station.
- Contains tables of Key Headquarters Personnel and MAJCOM Commanders.

**DEPARTMENT OF DEFENSE DIRECTIVES****DoDD 5015.77—National Guard Bureau. May 21, 2008.**

- Establishes DoD policy for and defines the organization, management, responsibilities and functions, relationships and authorities of the Chief of the National Guard Bureau.

**Council of Governors****EXECUTIVE ORDERS****Ex. Ord. 13528 of January 11, 2010 (Published at 75 FR 2053)— Establishment of Council of Governors.**

- Establishes the Council of Governors and sets forth its organization.
- Sets forth participants in Council meetings and issues that are within the Council's purview.
- Department of Defense Directives

**DoD Memorandum—State-Federal consultative process for programming and budgetary proposals affecting the National Guard. February 25, 2013.**

- Sets forth DoD policy that DoD and the states, territories, and the District of Columbia, represented through the Council of Governors, will engage in a sustained process to exchange views, information, and advice on programming and budgetary proposals affecting the National Guard.
- Establishes objectives and implementation to consultations and dialogue between the DoD and states (through Council of Governors).

**Defense Support for Civil Authorities (DSCA)****STATUTES****10 U.S.C. §372—Use of military equipment and facilities.**

- Permits The Secretary of Defense to make available any DoD equipment, base facility or research facility to any Federal, State, or local civilian law enforcement official for law enforcement purposes.

**10 U.S.C. §373—Training and advising civilian law enforcement officials.**

- Permits the Secretary of Defense to make available DoD personnel to (1) train federal, state, and local civilian law enforcement officials in the operation and maintenance of equipment and (2) provide "expert advice" to law enforcement officials.

**10 U.S.C. §374—Maintenance and operation of equipment.**

- Sets forth the purposes for which the Secretary of Defense can make DoD personnel available to operate DoD equipment for DSCA purposes.

**10 U.S.C. §375—Restriction on direct participation by military personnel.**

- Requires the Secretary of Defense to prescribe necessary regulations to ensure that any activity, provision of equipment or facility, or assignment of personnel does not include or permit direct participation of the Army, Navy, Air Force, or Marine Corps in a search, seizure, arrest, or similar activity unless otherwise authorized by law.

**10 U.S.C. §376—Support is not to adversely affect military preparedness.**

- DSCA support, activities, provision of equipment or facilities, or assignment of personnel is prohibited if provision of that DSCA support will adversely affect the military preparedness of the United States.

**10 U.S.C. §377—Reimbursement.**

- A civilian law enforcement agency to which DSCA support is provided is required to reimburse DoD for the costs of that support.
- Contains language on credits for support by National Guard and waiver of reimbursement for support under 32 U.S.C. §502(f).

**10 U.S.C. §380—Enhancement of cooperation with civilian law enforcement officials.**

- Requires the Secretary of Defense to conduct an annual briefing of law enforcement personnel of each state regarding information, training, technical support, and equipment and facilities available to civilian law enforcement personnel from DoD.
- Also contains information required to be included in the Secretary of Defense’s annual briefing.

**10 U.S.C. §381—Procurement of equipment by State and local governments through the Department of Defense: equipment for counter-drug, homeland security, and emergency response activities.**

- Requires the Secretary of Defense to establish procedures under which states and units of local governments may purchase equipment through DoD suitable for counter-drug, homeland security, and emergency response activities.
- Includes requirements for purchasing procedures and requests.

**10 U.S.C. §382—Emergency situations involving weapons of mass destruction.**

- The Secretary of Defense may authorize DoD resources to be used to provide assistance in support of U.S. Department of Justice activities related to an emergency situation involving a weapon of mass destruction.
- Defines “emergency situation involving a weapon of mass destruction” and forms of assistance permitted under this section.

## Duty Statuses and Definitions

### STATUTES

**10 USC §101—Definitions.**

- Defines various duty statuses for military personnel.
- Defines “full-time National Guard duty.” (See also 32 U.S.C. § 101(19) for corresponding National Guard section.)
- Defines “active Guard and Reserve duty,” but does not include support of Active Component units assigned to train with or be trained by Reserve Component personnel.

**10 U.S.C. §10216—Military technicians (dual status).**

- Defines dual-status military technician and their duties and management.
- Does not contain language for support of Active Component units assigned to train with or be trained by Reserve Component personnel.

**10 U.S.C. §10217—Non-dual status technicians.**

- Defines non-dual status technicians and their employment opportunities and personnel caps by component.

**10 U.S.C. §12310—Reserves: for organizing, administering, Reserve Components.**

- Does not contain language for support of Active Component units assigned to train with or be trained by Reserve Component personnel.

**10 U.S.C. §12314—Reserves: any kind of duty.**

- A member of a Reserve Component who is on active duty other than for training may, under regulations prescribed by the Secretary concerned, be detailed or assigned to any duty authorized by law for members of the Active Component for the Air Force.

**10 U.S.C. §12318—Reserves on active duty: duties; funding.**

- Establishes Reserve Component duties while on active duty as those contained within the applicable mobilization authority.
- Establishes authorities under which funding will be available for the pay and allowances of Reserves.

**32 U.S.C. §101—Definitions.**

- Defines active duty for National Guard.
- Defines “full-time National Guard duty” (See 10 U.S.C. § 101(d)(5) for corresponding section.)



**32 U.S.C. §328—Active Guard and Reserve duty: Governor’s authority.**

- Does not contain language including support of Active Component units assigned to train with or be trained by Reserve Component personnel.

**32 U.S.C. §502—Required drills and field exercises.**

- Contains language permitting a member of the National Guard to be ordered to perform training or other duty in addition to what is set forth in subsection (a) of the statute.
- Contains examples of training or other duties permitted to be performed by the National Guard under this section.

**32 U.S.C. §709—Technicians: employment, use, status.**

- Does not contain language including support of Active Component units assigned to train with or be trained by Reserve Component personnel.

## AIR FORCE INSTRUCTIONS

**AFI 36-2132V2—Active Guard/Reserve (AGR) Program.**

- Section 2.9. Deployment of AGRs. Does not include in the AGR duties language permitting support of Active Component units who train or deploy with Reserve Component units or personnel.

## End Strength

### STATUTES

*Note: End Strength levels also contained within National Defense Authorization Act for each fiscal year.*

**10 U.S.C. §12001—Authorized strengths: Reserve Components.**

**10 U.S.C. §12002—Authorized strengths: Army and Air Force Reserve Components, exclusive of members on active duty.**

**10 U.S.C. §12003—Authorized strengths: commissioned officers in an active status.**

**10 U.S.C. §12004—Strength in grade: Reserve general and flag officers in an active status.**

**10 U.S.C. §12005—Strength in grade: commissioned officers in grades below brigadier general or rear admiral (lower half) in an active status.**

**10 U.S.C. §12006—Strength limitations: authority to waive in time of war or national emergency.**

**10 U.S.C. §12008—Army Reserve and Air Force Reserve: warrant officers.**

**10 U.S.C. §12009—Army and Air Force Reserve Components: temporary increases.**

**10 U.S.C. §12011—Authorized strengths: Reserve officers on active duty or on full-time National Guard duty for administration of the Reserves or the National Guard.**

**10 U.S.C. §12012—Authorized strengths: senior enlisted members on active duty or on full-time National Guard duty for administration of the Reserves or the National Guard.**

## Funding and Procurement

### STATUTES

**10 U.S.C. §231a—Budgeting for life-cycle cost of aircraft for the Navy, Army, and Air Force: annual plan and certification.**

- Sets forth requirements for procurement plans for aircraft and itemizes aircraft covered by these procurement plans.

**10 U.S.C. §235—Procurement of contract services: specification of amounts requested in budget.**

- Sets forth requirement for the Secretary of Defense to include in his or her annual budget request the numbers of projected full-time contractor employees and amount requested for procurement of these services.

**10 U.S.C. §377—Reimbursement.**

- See also DSCA section, above.

**10 U.S.C. §381—Procurement of equipment by state and local governments through the Department of Defense: equipment for counter-drug, homeland security, and emergency response activities.**

- See also DSCA section above.

## DEPARTMENT OF DEFENSE DIRECTIVES

### DoDD 7045.14—The Planning, Programming, Budgeting, and Execution (PPBE) process. January 25, 2013.

- Updates established policy and assigned responsibilities for the PPBE process.
- Provides PPBE process descriptions and data release restrictions.
- This directive applies to the Office of the Secretary of Defense, the Military Departments, the Office of the Chairman of the Joint Chiefs of Staff and the Joint Staff, the Combatant Commands, the Office of the Inspector General of the Department of Defense, the Defense Agencies, the DoD Field Activities, and all other organizational entities within DoD.

### DoD Memorandum—State-federal consultative process for programming and budgetary proposals affecting the National Guard. February 25, 2013.

- See also Council of Governors section above.

## Human Capital

### *Continuum of Service*

#### STATUTES

#### 10 U.S.C. §10213—Reserve Components: dual membership prohibited.

- Prohibits any individual from being part of more than one Reserve Component at the same time.

#### 10 U.S.C. §12103—Reserve Components: terms.

- Sets forth terms under which enlisted members of the Reserve Components serve.
- Includes time required on active duty and the Ready Reserve.

#### 10 U.S.C. §12014—Reserve Components: transfers.

- Sets forth ability for a member of the armed forces to transfer into the Reserve Component of that armed force.
- Limits ability for a member of the armed forces to transfer into the Reserve Component of another military branch in lieu of the transferring between components of the same armed force.

#### 10 U.S.C. §12105—Army Reserve and Air Force Reserve: transfer from Guard Components.

- Permits the Secretary of the Air Force to prescribe

regulations governing transfer of an enlisted member of the Air National Guard of the United States (federal) into the Air Force Reserve.

- Requires consent of governor or other appropriate state authority for the transfer.

#### 10 U.S.C. §12106—Army and Air Force Reserve: transfer to Reserve upon withdrawal as member of National Guard.

- An enlisted member of the Air National Guard who ceases to become a Guardsman automatically becomes a member of the Air Force Reserve unless also discharged from that component.
- Upon becoming a member of the Air Force Reserve, the enlisted member no longer is a member of the Air National Guard of the United States.

#### 10 U.S.C. §12108—Enlisted members: discharge or retirement for years of service or for age.

- Each Reserve enlisted member of the Air Force who is in active status and has reached either maximum age or maximum years of service shall be transferred to the Retired Reserve, if qualified.

#### 10 U.S.C. §12214—Officers; Air Force Reserve: transfer from Air National Guard of the United States.

- An officer of the Air National Guard of the United States may be transferred in grade to the Air Force Reserve. This requires consent of the governor and other appropriate authorities of the state concerned.
- Upon becoming an officer of the Air Force Reserve, the officer ceases to be a member of the Air National Guard of the United States.

## Promotion Boards

#### STATUTES

#### 10 U.S.C. §14101—Convening of selection boards.

- Selection boards are convened only for promotion or selective early separation.

## Promotion, Failure of Selection

### STATUTES

10 U.S.C. §627—Failure of selection for promotion.

10 U.S.C. §14501—Failure of selection for promotion.

- Addresses failure of selection for promotion for Reserve officers below the grade of colonel or those twice failed of selection.

10 U.S.C. §14503—Discharge of officers with less than six years of commissioned service or found not qualified for promotion to first lieutenant or lieutenant (junior grade).

10 U.S.C. §14504—Effect of failure of selection for promotion: Reserve first lieutenants of the Army, Air Force, and Marine Corps and Reserve lieutenants (junior grade) of the Navy.

10 U.S.C. §14505—Effect of failure of selection for promotion: Reserve captains of the Army, Air Force, and Marine Corps and Reserve lieutenants of the Navy.

10 U.S.C. §14506—Effect of failure of selection for promotion: Reserve majors of the Army, Air Force, and Marine Corps and Reserve lieutenant commanders of the Navy.

10 U.S.C. §14513—Failure of selection for promotion: transfer, retirement, or discharge.

## Promotion Timing, Zones, and Opportunity

### STATUTES

10 U.S.C. §14301—Eligibility for consideration for promotion: general rules.

10 U.S.C. §14311—Delay of promotion, involuntary.

10 U.S.C. §14312—Delay of promotion: voluntary.

10 U.S.C. §14315: Position vacancy promotions: Army and Air Force Officers.

## Retirement for Age and Years Of Service

### STATUTES

10 U.S.C. §633—Retirement for years of service: Active lieutenant colonels and commanders.

- Contains language requiring Air Force lieutenant colonels not on the promotion list to be retired upon completion of 28 years of Active commissioned service.

10 U.S.C. §8911—Twenty years or more: Active or Reserve commissioned officers.

- Corresponding statutes for other armed forces are 10 U.S.C. §3911 (Army) and 10 U.S.C. §6323 (Navy and Marine Corps).
- Permits retirement of an Active or Reserve commissioned officer with at least 20 years of service, 10 of which must have been as an Active commissioned officer.

10 U.S.C. §10218—Army and Air Force Reserve technicians: conditions for retention: mandatory retirement under civil service laws.

- Sets forth requirements for when an Air Force Reserve technician loses dual status due to age.
- Sets forth requirements for when a non-dual status Air Force Reserve technician is retired.

10 U.S.C. §12108—Enlisted members: discharge or retirement for years of service or for age.

- Requires a Reserve enlisted member on active status who has reached maximum years of service or age to be transferred to the Retired Reserve or discharged.

10 U.S.C. §12108—Enlisted members: discharge or retirement for years of service or for age.

- Requires a Reserve enlisted member on active status who has reached maximum years of service or age to be transferred to the Retired Reserve or discharged.

10 U.S.C. §12646—Commissioned Officers: retention of after completing 18 or more, but less than 20, years of service.

10 U.S.C. §14509—Separation at age 62: Reserve officers in grades below brigadier general or rear admiral (lower half).

10 U.S.C. §14510—Separation at age 62: brigadier generals and rear admirals (lower half).

10 U.S.C. §14511—Separation at age 64: officers in grade of major general or rear admiral and above.

10 U.S.C. §14512—Separation at age 66: officers holding certain offices.

10 U.S.C. §14513—Failure of selection for promotion: transfer, retirement, or discharge.

10 U.S.C. §14514—Discharge or retirement for years of service or after selection for early removal.

10 U.S.C. §14515—Discharge or retirement for age.

## Selective Continuation and Retention

### STATUTES

10 U.S.C. §637—Selection of regular officers for continuation on active duty.

10 U.S.C. §12308—Retention after becoming qualified for retired pay.

- Permits any person who has qualified for retirement pay to be retained on active duty or in the service of a Reserve Component. Retention may be done with the consent of the individual Airman and by order of the Secretary concerned.

10 U.S.C. §14701—Selection of officers for continuation on the Reserve active-status list.

## Total Force Management

### General Policy

### STATUTES

10 U.S.C. §129a—General policy for total force management.

- Provides the Secretary of Defense with authority to establish policies and procedures for mix of military, civilian and contractor personnel.
- Requires use of certain planning documents and inventory in determining total force mix.

10 U.S.C. §194—Limitations on personnel.

- Caps total numbers of armed forces and civilian employees assigned or detailed to Defense Agencies

and Department of Defense Field Activities, both at headquarters and other support levels.

10 U.S.C. §10102—Purpose of Reserve Components.

- Describes purpose of Reserve Components as providing trained units and qualified persons available for active duty in the armed forces under certain circumstances.

10 U.S.C. §10103—Basic policy for order into federal service.

- Sets forth basic policy for ordering Title 10 Reserve forces and Title 32 status National Guardsmen into active duty.

10 U.S.C. §12301—Reserve Components generally.

- Sets forth circumstances under which Reserve forces may be ordered into active duty.

10 U.S.C. §12302—Ready Reserve.

- Sets forth circumstances under which Ready Reserve may be ordered into active duty.

10 U.S.C. §12304—Selected Reserve and certain Individual Ready Reserve members; order to active duty other than during war or national emergency.

- Sets forth authority and circumstances under which the Selected Reserve and Individual Ready Reserve members may be ordered into active duty.

10 U.S.C. §12304a—Army Reserve, Navy Reserve, Marine Corps Reserve, and Air Force Reserve: order to active duty to provide assistance in response to a major disaster or emergency.

- Sets forth authority and limitations for when Air Force Reserve may be ordered into active duty following a Governor's request for federal assistance pursuant to the Stafford Act.

10 U.S.C. §12304b—Selected Reserve: order to active duty for preplanned missions in support of the Combatant Commands.

- Sets forth authority and limitations for when Selected Reserve may be ordered into active duty to augment active forces for a preplanned mission in support of a Combatant Command.

10 U.S.C. §12306—Standby Reserve.

- Sets forth circumstances under which Standby Reserve may be ordered into active duty.

**10 U.S.C. §12307—Retired Reserve.**

- Sets forth circumstances under which a member of the Retired Reserve may be ordered into active duty.

## Military Discipline

### STATUTES

**10 U.S.C. §§801-941—Uniform Code of Military Justice.**

- The UCMJ courts-martial have jurisdiction over certain categories of airmen, including:
  - Active Component service members, including those awaiting discharge, inductees, and retirees;
  - Aviation cadets;
  - Members of the Air Force Reserve, including activated Reservists, traditional part-time Reservists performing either full-time active duty for a specific period or inactive duty training, or retirees receiving hospitalization from an armed force;
  - Persons serving with or accompanying an armed force in the field in a time of declared war or contingency operation; and
  - Air National Guard service members only when in Federal service.

**32 U.S.C. §326—Courts-martial of National Guard not in federal service: composition, jurisdiction, and procedures.**

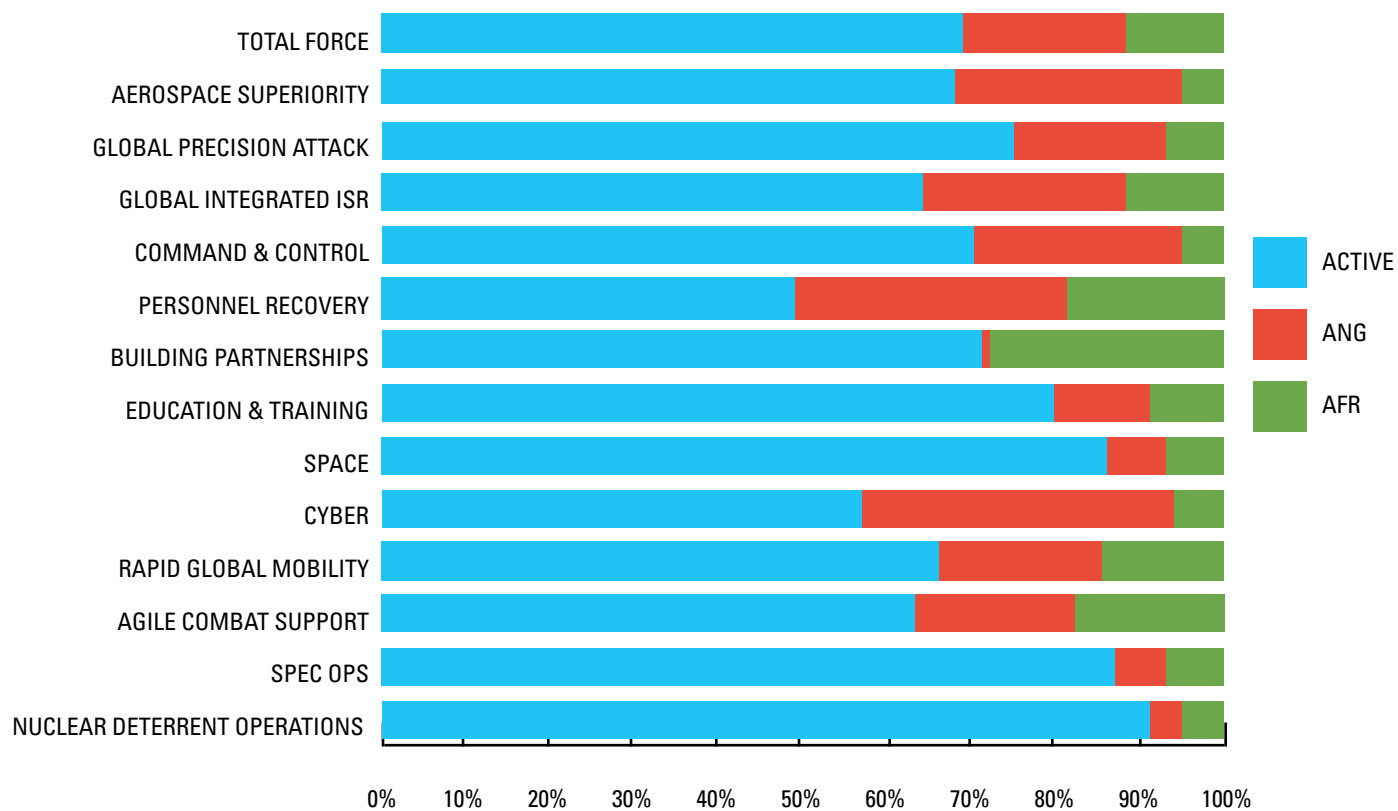
- When the Air National Guard is not in federal service, it is subject to separate Title 32 courts-martial. Title 32 courts-martial are like UCMJ courts-martial for Air Force service members as to forms and procedures. Where they are different is in punishment by the laws of the respective states instead of those proscribed by the UCMJ courts-martial system. Additionally, State systems do not provide for automatic post-trial review of convictions, as does the UCMJ.



## APPENDIX K

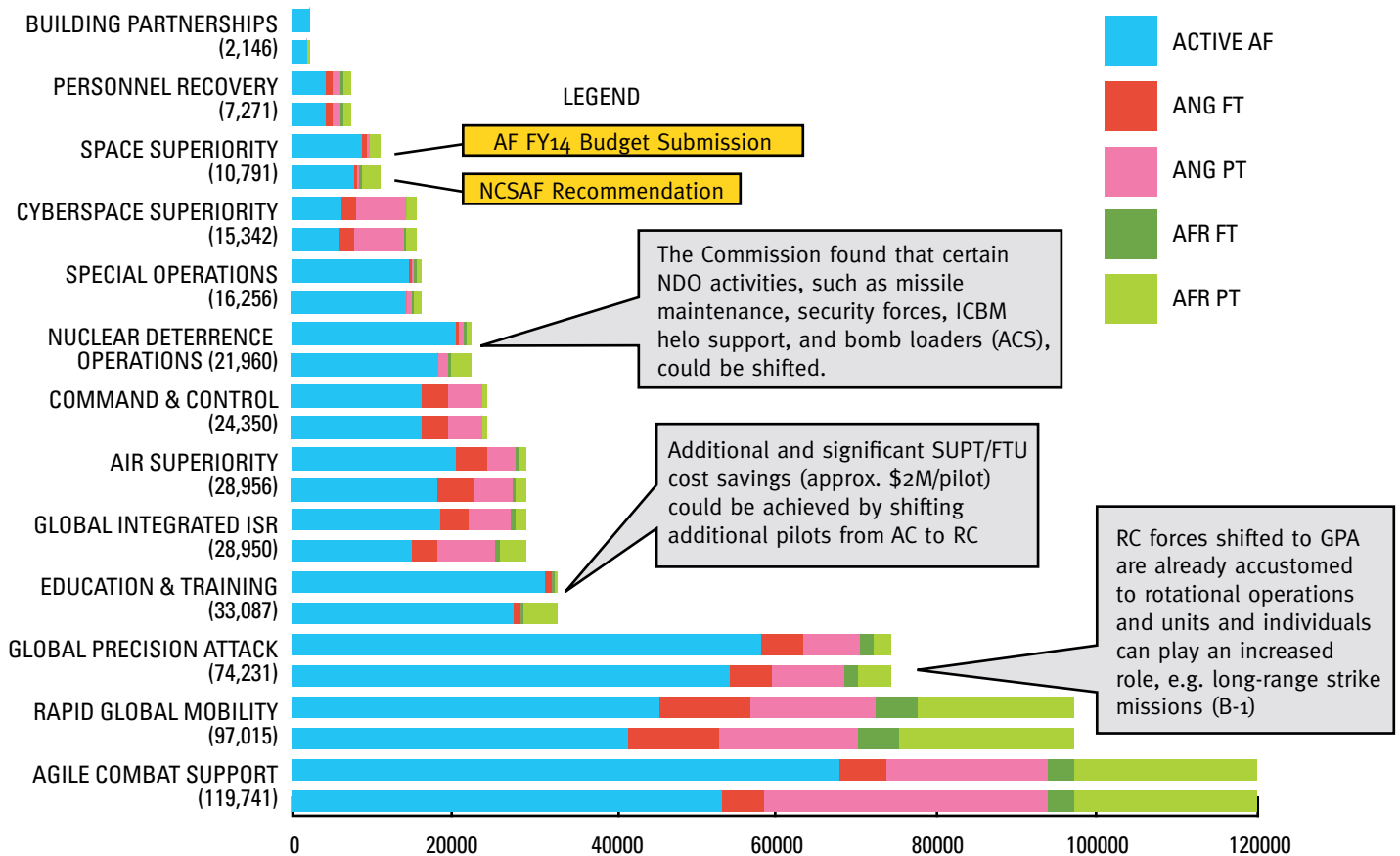
# CORE FUNCTION BALANCE

FIGURE 7: **Current Component Share of Total Manpower by Core Function**



Source: Air Force PB14 data. Does not include certain personnel such as unassigned students, separations, retirements, medical, and prisoners.

FIGURE 8: **Example of Alternative Core Function Mix from 65%:35% AC:RC to 58%:42% AC:RC**



Source: FY14 Unit Manning Data Provided by the Air Force, December 2013. Does not include certain personnel such as unassigned students, separations, retirements, medical, and prisoners.

**Examples of specific shifts from Active Component to Reserve Component**

- Air Superiority: Savings derived from the i-Wing construct allows a shift of 1,875.
- Global Precision Attack: Savings derived from the i-Wing and specific force redistributions, such as bomb loaders, results in a shift of 3,750; included would be the reassignment of the B-1 to the Air Force Reserve, to prepare for concurrent proportional fielding of Long-Range Strike Bomber, and 500 to Special Operations.
- Global Integrated ISR: A small percentage shift of 3,875 Offensive Cyber Operations (OCO)-type intel and data analysis positions.
- Command and Control: no change.
- Personnel Recovery: no change.
- Building Partnerships : A shift of 250 for training development and partner education.
- Education and Training: Additional and significant cost savings, as well as the shift of some pilots to the Active Component operational force can be accomplished by the shift of 3,725.
- Space Superiority: A small shift of 1,125 to the Reserve Component in areas suited for 24/7 augmentation.
- Cyberspace Superiority: Some additional cost savings could be realized by incorporating 450 of the planned Cyber growth in the Reserve Component.
- Rapid Global Mobility: Savings derived from the i-Wing construct allows additional shift of 3,800.
- Agile Combat Support: A force redistribution retains the Air Force’s capacity by the shift of 14,100 (examples include NDO bomb loaders).
- Special Operations: A small growth of 1,000 in the Reserve Component of which 500 would be shifted.
- Nuclear Deterrence Operations: Rife with new Reserve Component mix opportunities; as many as 2,500 NDO positions could be shifted (missile maintenance, ICBM helicopter support, security forces, and some B-52 operations and support).

## APPENDIX L

# ADVANCED DECISION SUPPORT TOOL

The starting point for the ADST was previous analysis and graphical design developed by AF/A9 to inform and illustrate Air Force force structure decisions in the FY13 PB submission.

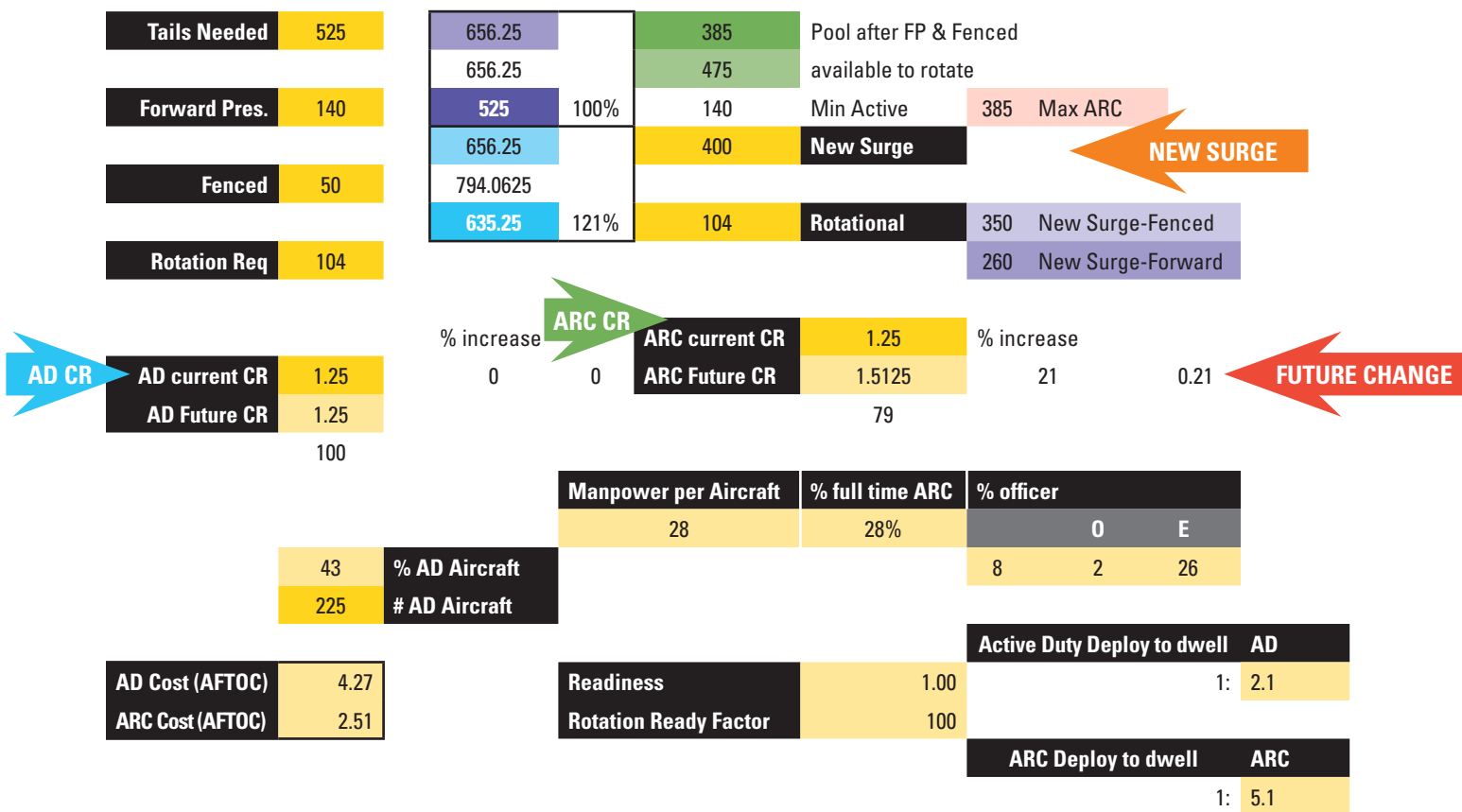
The Advanced Decision Support Tool (ADST) is a model which can analyze and evaluate future force structure alternatives based on various data inputs of the decision maker's choosing. The ADST is specifically designed to inform cost and equipment inventories, as well as AC/RC mix decisions. This is a decision support tool and is not intended to provide decision makers with final optimized solutions. Rather, it can rapidly calculate and portray a range of feasible decision options for force structure and policy decisions based on variable inputs.

A key feature of the ADST is the design format that allows for a variety of variable inputs that are scalable with





“sliders” to dynamically visualize the changes to cost as a result of manipulating the input variables. Example input variables used by the NCSAF staff were force structure, crew ratios, and readiness factors. These variables provided the groundwork for the tool's analytic calculations. The ADST allows decision-makers to consider numerous alternatives to meet reduced budget funding levels, such as adjusting the crew ratio, changing readiness, or modifying the dwell period, singularly or collectively; all variables are linked to overall cost to the enterprise and are displayed in real time. While data sources are of the user's choosing, data sources used by the NCSAF staff include, but are not limited to, open source information, AFTOC data, ISC assumptions and AFI 65-503 references.

Following are pictorial representations of the ADST, along with narrative descriptions of its use.

FIGURE 9: Cost Calculator and Rotational Capacity

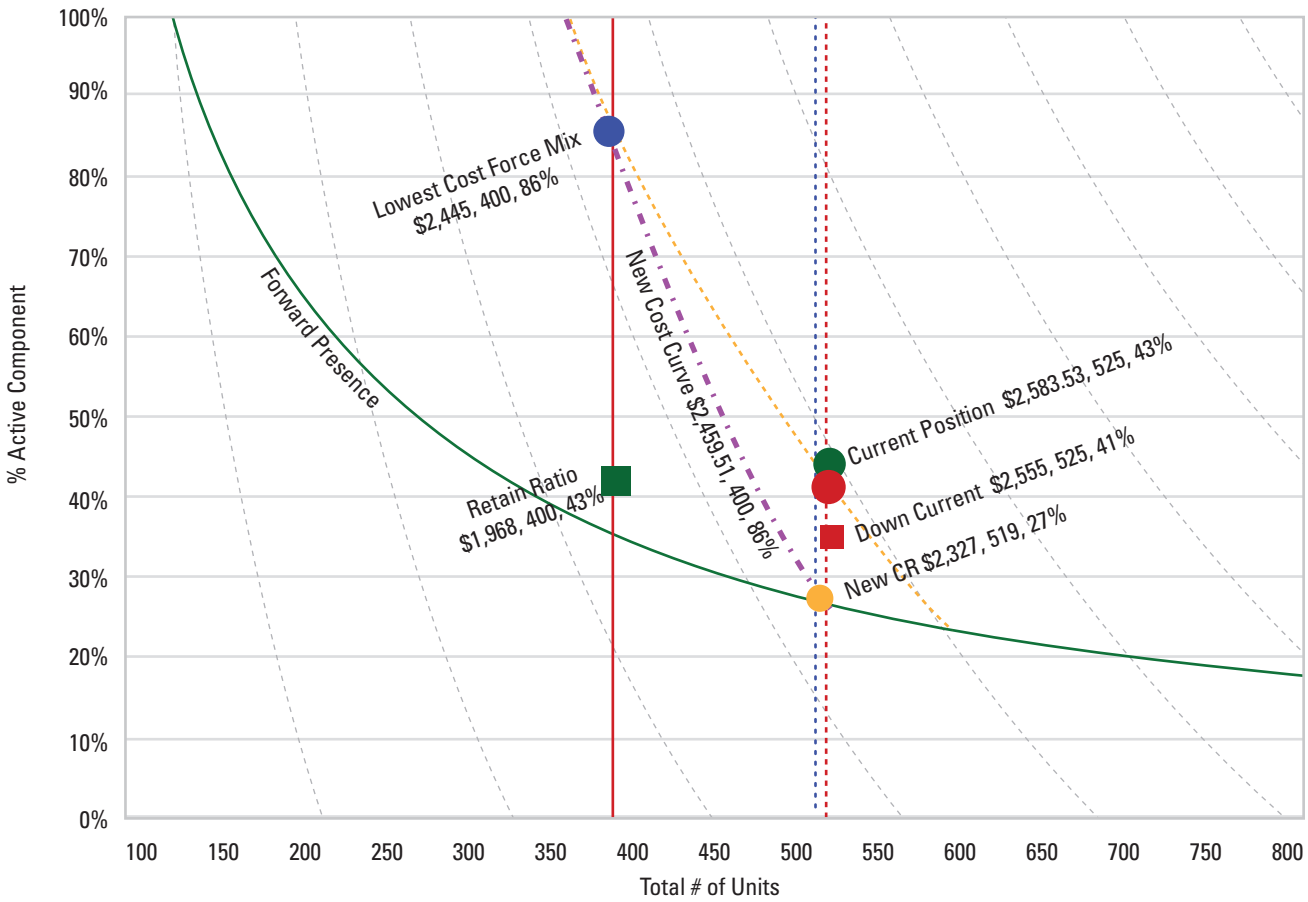


**Notional Weapons System Characteristics**

-  AD Crew Ratio (CR) of 1.25
-  ARC CR of 1.25
-  Future change to 1.5
-  New Surge requirement was modified to 400

\*\*Above is a pictorial representation of notional inputs to the tool. On the following page is the resulting graphic illustrating the result of the calculations and the effects on the cost curves.

FIGURE 10: Rotational Demand Impacts on Force Mix

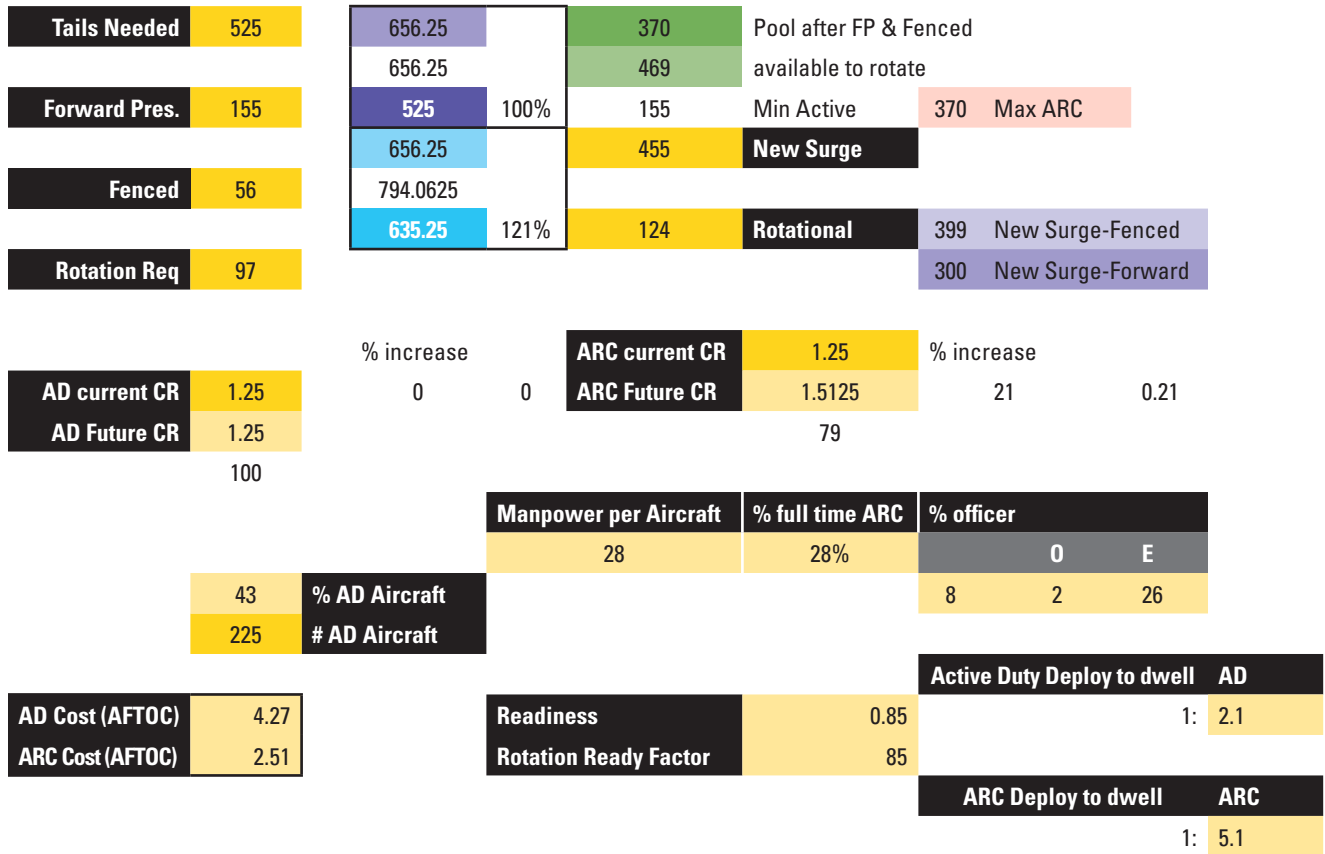


Graphical depiction of the range of force mix options, tailorable to input variables.



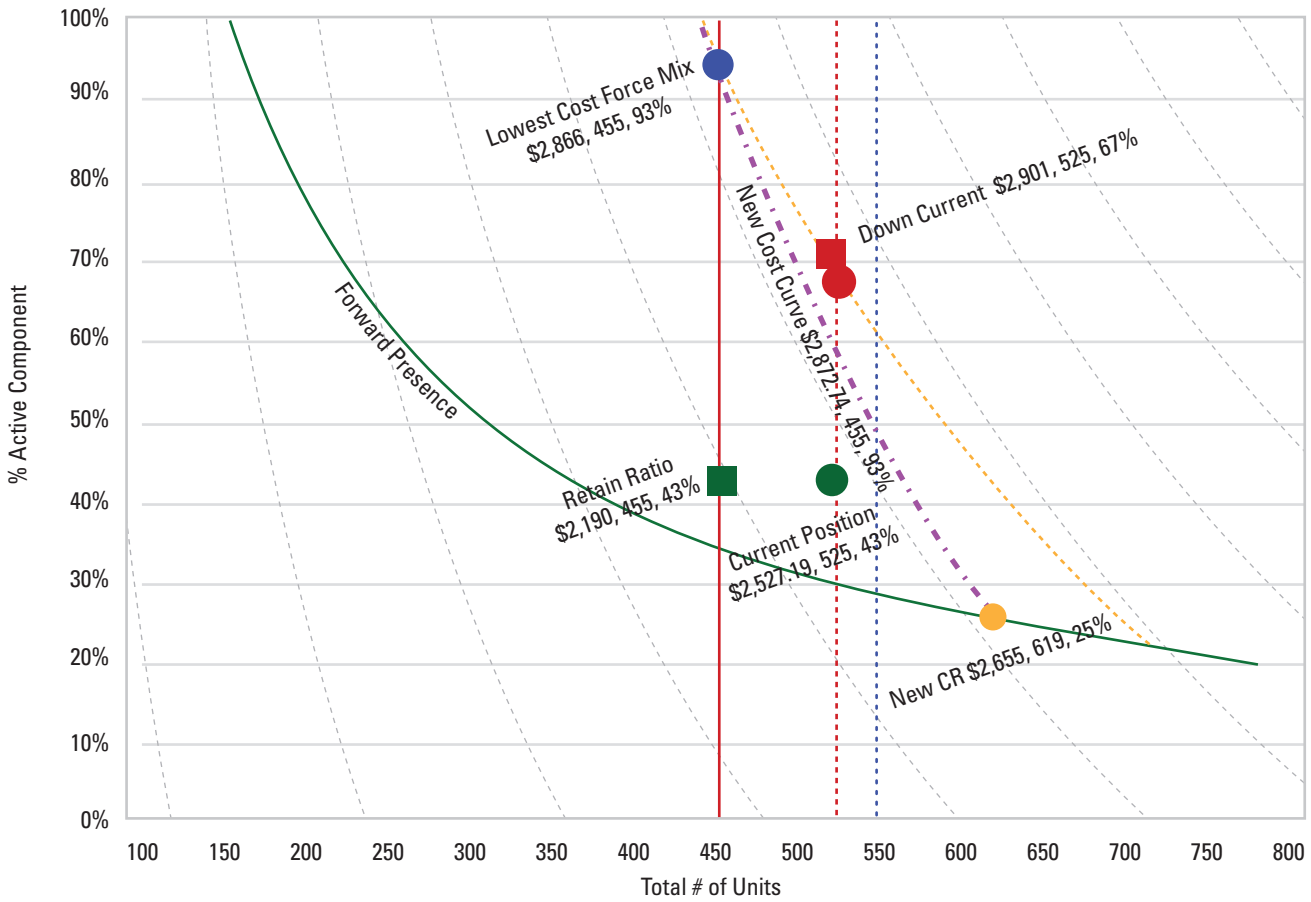


FIGURE 11: Cost Calculator and Rotational Capacity



\*\*The above represents changing variables for decision makers to consider. Following is a graphical portrayal of the outcome.

FIGURE 12: Rotational Demand Impacts on Force Mix



From this second graphic you can see the range of options in both cost and capability that are nearly instantly available for decision makers to evaluate. A notional force of 450 aircraft at 85% readiness are lower cost than a 100 % ready force with only 400 aircraft that has a Higher percentage of Active Component manpower. It also has greater Surge and more aircraft available in 72 hours. The tool allows the Decision Maker to explore all variables to meet both defined and undefined options.

Graphical depiction of the range of force mix options, tailorable to input variables.



## APPENDIX M

# NCSAF WAR GAME

### Purpose

This war game was designed to provide the Commissioners with insight into issues under their consideration through a force planning game. In this seminar game, Commissioners and Staff players progressed through a series of challenging decisions that were intended to reveal planning results and implementation difficulties of alternative force structures, informing Commissioners on how to balance the equation between the cost of preparing for an uncertain future and the risk of not doing so. As a result of this war game, Commissioners took away a sharper understanding of the policy choices they considered, a more rigorous analytic assessment of the implications of their emerging findings, and a more credible basis upon which to articulate their recommendations.

### Objectives

- Assess the advantages and disadvantages of contending approaches to the future structure of the Air Force;
- Identify current policies, procedures, practices and legislation that need to change in order to make the future structure of the Air Force more effective;
- Understand stakeholder interests in the future structure of the Air Force and assess their likely responses to the Commission's findings and recommendations.

This war game focused on the implications of potential changes to the force structure mix among the three components (Active, Reserve and Air National Guard) across and within the range of Air Force capabilities. It did not aim to focus on other objectives sometimes war-gamed such as campaign outcomes, institutional revolutionary change, major investment portfolio rebalancing, future warfighting operational and organizational concepts, or Joint Capabilities Analysis. The game design did, however, seek to reveal potential strengths and weaknesses to force planning changes that affected those factors through additional post-game review, research and analysis. An additional objective of the game was to evaluate potential repeatable decision support processes for either further evaluation, post-Commission change implementation, or future evaluation of potential choices for the other Services.

### Concept

The Commissioners expressed a strong preference to conduct a war game exercise as a way to provide a rigorous and repeatable process to evaluate force structure decisions.

In seeking a way to rigorously test any potential reorganized Air Force force structure, the Research staff discussed future security and organization trends with the Office of Net Assessment (ONA) and ONA's assessment of war gaming best practices. The Center for Strategic and Budgetary Assessment (CSBA) and CSBA agreed to support the Commission's seminar-style war game with their Portfolio Rebalancing Tool, which has been applied to a number of DoD decision-making processes. The war game teams were urged to examine all Air Force enterprise areas for the potential for change, including infrastructure, human capital management, and operating costs. CSBA staff also acted as team advisors and force structure experts during the game.

The NCSAF Force Structure War game was designed for two stages. The first stage was a planning exercise in which three teams each developed a resource-constrained Air Force over the 2015-2023 planning period. A key assumption given to all three teams was that the current budget environment would remain constrained. In the second stage, the teams played the role of the Air Force as force provider to the COCOMs, who had competing requirements, in a demanding scenario that occurred in or about 2018. Across both events, the independent variable of interest was force structure, while the dependent variables were cost-effectiveness and mission-effectiveness. Players were provided analytic tools to enable them to build their assigned force structure by manipulating a set of control variables that enabled costed force structure choices.

### Assumptions

- Resources available were constrained by BCA and Sequestration in accordance with the most stressing forecast developed by CAPE in the course of the Strategic Choices Management Review (SCMR).
- Each alternative force structure considered was based upon the FY15 Alternative Program Objective Memorandum (FY 15 Alt POM) as a starting point.
- Compensation changes did not begin to produce

significant fiscal effects for Service budgets during the game planning horizon.

- Current basing infrastructure must be maintained for the near term, but adjustments could be considered in order to adapt to force structure changes in future years. Teams could vary the stationing of forces, but could not close bases nor reap the fiscal payoff during their planning horizon.
- Total Air Force End Strength at the beginning of the exercise would be consistent with FY15 Alt POM levels.
- Economic influences on recruiting and retention was derived by Game Control based on an economic forecast that presumed steady but slow growth over this time period.
- Invert the planning paradigm for sizing the force as follows:
  - Assume AF will continue to sustain readiness and proficiency levels at which Active, Guard and Reserve units are held to the same goals;
  - Assuming 1:5 Deploy-To-Dwell ratio for the Reserve Components, and 1:2 for the Active Component, resource 20% of the RC for Full-Time service to meet Day-To-Day Requirements on the Air Force. If the DTD ratios are changed, resource the RC Full-Time forces proportionately;
  - Resource to creatively access the remaining 80% of the RC as Traditional Guard/Reserve to apply against remaining Day-to-Day demands on the Air Force;
  - Assume streamlined authorities maintain or improve accessibility as needed;
  - Assess policies and practices needed to sustain sufficient rates of volunteerism;
  - Resource the Active Component to meet:
    - Remaining Day-to-Day requirements;
    - Additional Support to the Institutional Air Force for Training, Schools and seasoning;
    - All forces thus planned and programmed would be available for surge to Go-To-War, assess risk against the Go-To-War scenarios.

### Basic Design Construct

One team was instructed to develop a future Air Force with an active-reserve Component mix as was the case for FY15 (approximately 65% AC-35% RC). A second team built a future Air Force with a somewhat larger Active Component (75% AC 25% RC). The third team programmed and planned for a larger Air Force Reserve and Air National Guard (35% AC – 65% RC). These were analytic constructs and not to be construed to imply Commissioner preferences for any particular force structure. It was envisioned that

the analysis of alternatives may reveal where one or more design may fail, or alternatively that there are no significant differences among them. Such outcomes, however counterintuitive they may be, were intended to provide insight, not final answers. These three alternatives were then subjected to assessment in a subsequent war game event. Stage 1 was a simulated Air Force Planning Force build; Stage 2 was a hypothesized Crisis Planning Exercise in which the teams acted as the Force Provider to meet contending Combatant Command requirements and other national priorities.

### Implementation

- The entire war game was classified as it applied Programming and Planning guidance and information employed by the DoD, particularly the classified Integrated Scenario Constructs (ISCs) future warfighting scenarios applied by the CJCS in the Chairman's Strategic Seminars.
- FACA compliance was enabled by advance notice of the Closed Meetings for Events 1 and 2 as well as the classified portion of the hotwash. Public comment was invited in advance of this war game design, and there was an open unclassified war game hotwash report and deliberation to which the public was invited.
- War game was conducted at the Commission's Crystal City facility on Dec. 5 (Force Provider Crisis Planning Exercise) and Dec. 6 (Hotwash).

### Stage One: Capstone Force Planning Exercise

Each team built a future Air Force within their assigned structure mix among the components, using more detailed resource and planning guidance to supplement the assumptions specified above. In order to fit their planned force structure within the constraints of their guidance, each team was allowed to vary other dimensions such as readiness levels, deploy-to-dwell ratios, component mix among and within core functions and mission sets, total capacity available within a particular mission set or core function (teams could opt to divest a specific MDS so long as the mission could be accomplished by other Air Force capabilities within the delineated constraints. This was a limiting factor to exploring alternatives, considering that the CSBA Portfolio Rebalancing Tool used by the teams supported the entire DoD capabilities portfolio), mobilization authorities and human capital management policy and practice. The objective for each team was to develop a future force structure that optimized cost effectiveness, as determined by the teams' collective judgment of capability vs. cost.

A Control Team comprised of key analysts, researchers, and assigned CSBA personnel applied the quantitative boundaries of the exercise and supported the respective analytic approaches employed by all 3 teams. This included the use of a decision support tool developed by the Air Force A9 staff and then modified by NCSAF Analysis to govern trade-offs among the control variables. The Control Team adjusted the Portfolio Rebalancing Tool through NCSAF Research to meet specific cost assumptions and allow Teams to focus on developing a balanced total force mix across the range of choices for all mission sets and core functions. Rapporteurs were assigned to each team in order to capture the discussion and decision-making dialogue for each team as well as the interaction with the stakeholders during the scheduled team briefs and hotwash discussion.

In the Capstone event on Dec. 5, each team briefed their force structure plan to a panel of Commissioners who developed their questions with key stakeholders' interests in mind, including The Congress, Office of the Secretary of Defense, the States (Governors, Adjutants General, Congressional Delegations, Emergency Preparedness Directors, State Legislatures, Communities, etc.), Joint Chiefs of Staff, Secretary of the Air Force, Chief of Staff Air Force, Associations. After reviewing each Blue Team's plan, Commissioners and Staff held a hotwash discussion that collected insights gained and instructions to the Blue teams for preparation for Stage 2.

### Analysis

Upon conclusion of Stage 1, the Control Team conducted an analysis of the cost-effectiveness of each of the final force structures produced by the three teams. This analysis was guided by the ongoing results of the Lines of Analysis outlined in the Commission's Analysis Plan and documented in the Issue Papers, Themes and Research Reports.

### Stage Two: Force Provider Crisis Planning Exercise

Stage 2 was a crisis planning exercise the next day at the strategic level of conflicts that occur in 2018. The scenario employed was adapted from the Chairman's Strategic Seminar involving a stressful crisis that rapidly devolves into a multi-theater conflict that also requires maintaining a sizable force in CONUS for Homeland Defense events. Stage 2 was classified S/NF, where each team would play the role of the USAF as Force Provider to the Combatant Commands and had available the force structure that they had developed in Stage 1. Each team was presented with a briefing on the starting conditions presented by the adversary and a set of adjudicated Combatant Command requirements that the Air Force was directed to meet by the Secretary of Defense.

Control provided these requirements in advance and each Team was given an identical set of briefing slides to complete, identifying which forces would be proposed to meet each requirement and the timelines that those forces would be available to the COCOM. Commissioners organized their questions to focus on stakeholder interest areas.

### Assessment

On completion of Stage 2, Commissioners and Staff held a hotwash to develop an overall assessment of the implications of the war game for Commissioners' consideration in their development of findings, conclusions and recommendations. The assessment included consideration of such issues as:

- Whether the three components should be integrated into a different arrangement,
- Can the forms of mobilization be further reduced and rationalized,
- Can additional functions be transferred to the civilian or contractor work forces,
- Infrastructure implications to force structure changes
- What legislative changes may be needed, and
- What additional issues were identified by the war game (impacts upon the Joint Force and the other Services).

The game control staff and CSBA staff offered the teams the following questions to answer as a baseline to assist the Commissioners' engagement and exploration of challenges encountered:

- **For Steady-State Requirements of the Operationally Stressing Case:**

Compared to the Alternative Program Objective Memorandum 2015 (FY 15 Alt POM) force, what is the capability / capacity of your rebalanced force to:

- Meet geographic COCOMs' theater presence requirements, including prepared to deploy requirements?
- Substitute for other Service capabilities that are unavailable to meet COCOM requests (e.g., substitute for carrier air wings to support presence)?
- Continue to support limited presence commitments in other theaters?
- Support COCOMs with more robust flexible deterrent options for two theaters?
- What are your most significant shortfalls?
- What actions did you take to offset / mitigate these shortfalls (force structure changes, force management initiatives)?
- **For Crisis (Surge) Requirements of the Operationally Stressing Case:**

Compared to the FY15 Alt POM force:

- Importance of early warning? Ability to respond to



the scenario given little or no prior warning?

- Importance of mobilization and degree of mobilization required?
- Ability of your force to sustain crisis (surge) level of effort for an extended (12 month) period of time?
- Ability to rapidly “swing” between the two operational theaters?
- In addition to the two contingency operations, ability to support an EPP or large-scale crisis in the Homeland?
- What are your most significant shortfalls?
- What actions did you take to offset / mitigate these shortfalls (force structure changes, force management initiatives)?

### Analysis

On conclusion of Stage 2, an analysis was conducted of the mission-effectiveness of each of the force structures produced by the three teams.

- Hotwash discussion – After completion of Stage 2, the teams produced a short presentation of their major findings as well as a recap of stakeholder questions that were asked. Each team spent two hours recounting the factors driving their decisions and answering follow on questions.
- Team Reports – each team spent a week writing a report on their war game results after receiving a report outline template from the Control Team, assisted by CSBA.
- Findings / Conclusions / Recommendations – using the results of the war game, the three teams were regrouped into teams that supported various draft Report chapters and provided draft findings, conclusions, and recommendations for consideration by the Commissioners.

### Commissioners’ / Team Leaders’ Key Insights

- In general, Commissioners wanted to better understand how recommended changes by the teams could be implemented and what a solid estimate of those costs incurred would be.
- For a force structure with less active duty endstrength and more Reserve component endstrength, surge requirements that boosted the need for part-time reserve component personnel should be studied for statutory and policy changes needed to provide the same capabilities required by COCOMs in the same timelines. There was not sufficient time to study these issues during the war game.

### 65% Active Duty / 35% Reserve Component Team:

- The team was able to achieve the desired 65/35 AC/RC mix in a sustainable, fiscally-achievable model
- 65/35 Air Force maintains the current combat capability demanded by COCOM Commanders in order to fly, fight, and win in Air, Space, and Cyberspace
- 65/35 Air Force’s targeted cuts to the O&M budget through lowered accessions and reduced training and readiness costs allows the AF to maintain its status quo capability and capacity while meeting the FY15 sequestered funding line
- Policy/Law/Human Capital Management proposals must ALL be met in order to create the environment for this model to succeed.
- Leadership must be willing to accept the risk associated with increasing the average age of the force, thinning accessions, and changing our readiness paradigm.

### 35% Active Duty / 65% Reserve Component Team:

- Force Management Risks:
  - RC may encounter multiple, simultaneous risks in shouldering many more staff billets, absorbing 2X number of inexperienced pilots, a looming “gray wave,” and ½ of RC is full time.
  - RC personnel could be seen as “second class citizens,” not good enough for AC and potentially resulting in morale decreases, personnel problems increase, retention decreases.
  - Employer push back strongly increases at pace with RC participation rates, a real concern already for RC Airmen.
  - New force mix career options are potentially unpopular and damage recruiting, undermining the historic AF advantage in attracting the best and brightest young people; well-known legacy examples of morale damage from Human Capital policies in a closed military system - takes years or decades to recover.
- Timeline Risks:
  - Long term sustainability
  - AC feeding RC
  - Recruitment, retention, affiliation
  - Unintended consequences and second/third order effects
  - No suitable models available
  - Timeline: Is it possible in 2 FYDPs?
  - Limited available assets for crisis management
  - Future resources uncertainty

- Operational Risks:
  - Increased risk to meet surge (MCO) operation(s) demand in terms of time
    - Accessibility of “first to fight” forces different (warning times vs. mobilization authority)
    - Availability of “first to fight” forces different (larger rotational force focused on steady-state vs. smaller active surge force) [Dependent upon where contingency kicks off]
    - Smaller “high-end” capacity may take longer to win the war or seize initiative in one theater as well as prolong ability to achieve deny in second theater
  - Increased risk of slight degradation in skill and proficiency of the force
    - Decreased size of the active force may result in temporary decrease in “seasoning” throughput to RC
    - Sequester resulting in both overall Air Force TAI and readiness decline potentially will negatively impact tooth-to-tail ratio in RC
- 55% Active Duty / 45% Reserve Component Team:
  - Retains the Alt POM 15 choices, and increases F-35 buys by 5 annually
  - Replacing 43,242 AC full-timers with 43,242 RC part-timers would:
    - Replace 40K AC FT wing mission support with 40K RC PT mission support in Associations on AC bases (~450/base) due to low deployed usage,
    - Replace 3,242 AC FT in strategic airlift, tankers, and bombers with 3,242 RC PT in Associations on AC bases due to mission fit,
  - Buys back flying hours/enhances readiness with ~\$1.5B annual savings generated by replacing FTs with PTs
  - The 55/45 Team speculated that moving 43K Mission Support personnel positions to part-time Reserve Component positions would also have the following force impacts:
    - Maintain or increase Operational Capabilities with an increased F-35 buy,
    - Maintain or reduce manpower costs through FT to PT conversion,
    - Maintain or increase Readiness by plowing back assumed Manpower savings,
    - Maintain Capacity with minor availability deficits,
    - Increase DSCA capacity by absorbing additional DSCA missions with new PT force structure,
    - Increase service Quality of Life by requiring some active duty members to move less,
    - Better community relations and recruitment/retention/affiliation through improved active duty stability and increased Reserve Component presence,
    - Increased Reserve Component part time service OPSTEMPO.

#### Future Improvements to the Work

Due to the time constraints involved, significant amounts of potential analysis is still present to be explored by follow on research and analysis efforts. The entirety of costing out enterprise changes that would need to accompany any significant force structure and/or human capital policy shifts remains to be explored. This effort could potentially avoid deeper cuts to capabilities or readiness and should be supplemented by a highly capable consulting firm with significant accounting experience assisting large, global corporations in conducting internal reorganizations or mergers. This approach is not without precedent as OSD and the Services currently employ such firms to discover and implement enterprise best practices. The depth of knowledge and experience in such efforts by these firms would likely be the difference between a successful transformation by the Air Force or another Service or Agency, and much more limited success if done internally. Numerous business case studies confirm the probability of success, depending upon the path taken.

There would be a significant advantage in further evaluating alternative force structure using a combination of the Decision Support Tool (as generated by the NCSAF staff), a Portfolio balancing Tool such as that provided by CSBA, and an enterprise, back office transformation effort with costed options that would be completed with the assistance of a qualified consulting firm. The efforts would work together synergistically to provide a deeper understanding of the costs of any transitions and efficient ways of reducing support costs as well. This modular approach would complement the war game findings and any potential follow on research. The Deputy Chief Management Officer (DCMO) for DoD is the executive agent for DoD management best practices and would be well-suited as a supporting office and body of knowledge repository for similar efforts by any Service or Agency.

# APPENDIX N

## AUTHORITIES

FIGURE 13: **Duty Status Comparison Chart**

	State Active Duty (SAD)	Title 32	Title 10
<b>Command and Control</b>	Governor	Governor	President
<b>Funding</b>	State	Federal	Federal
<b>Mission Types</b>	State law	Training and/or other federally authorized missions within CONUS	Federal Missions and duty performed within CONUS/OCONUS
<b>Military Discipline</b>	State Military Code	State Military Code	UCMJ
<b>Posse Comitatus Act</b>	Does not apply, but state law may have limitations	Does not apply, but state law may have limitations	Applies
<b>Stafford Act Reimbursement</b>	FEMA reimburses minimum of 75% to state	FEMA may reimburse DOD for per diem and travel for MA performance; reimbursement for P&A under consideration	Per diem and travel for performance of MA
<b>Benefits</b>	State law	<ul style="list-style-type: none"> <li>• Federal P&amp;A</li> <li>• Federal retirement points</li> <li>• FTCA</li> <li>• Medical/Disability</li> <li>• Family medical (&gt;30 days)</li> <li>• USERRA</li> <li>• SCRA (&gt;30 consecutive days and for National Emergency)</li> <li>• Death Gratuity</li> </ul>	Generally the same as T32

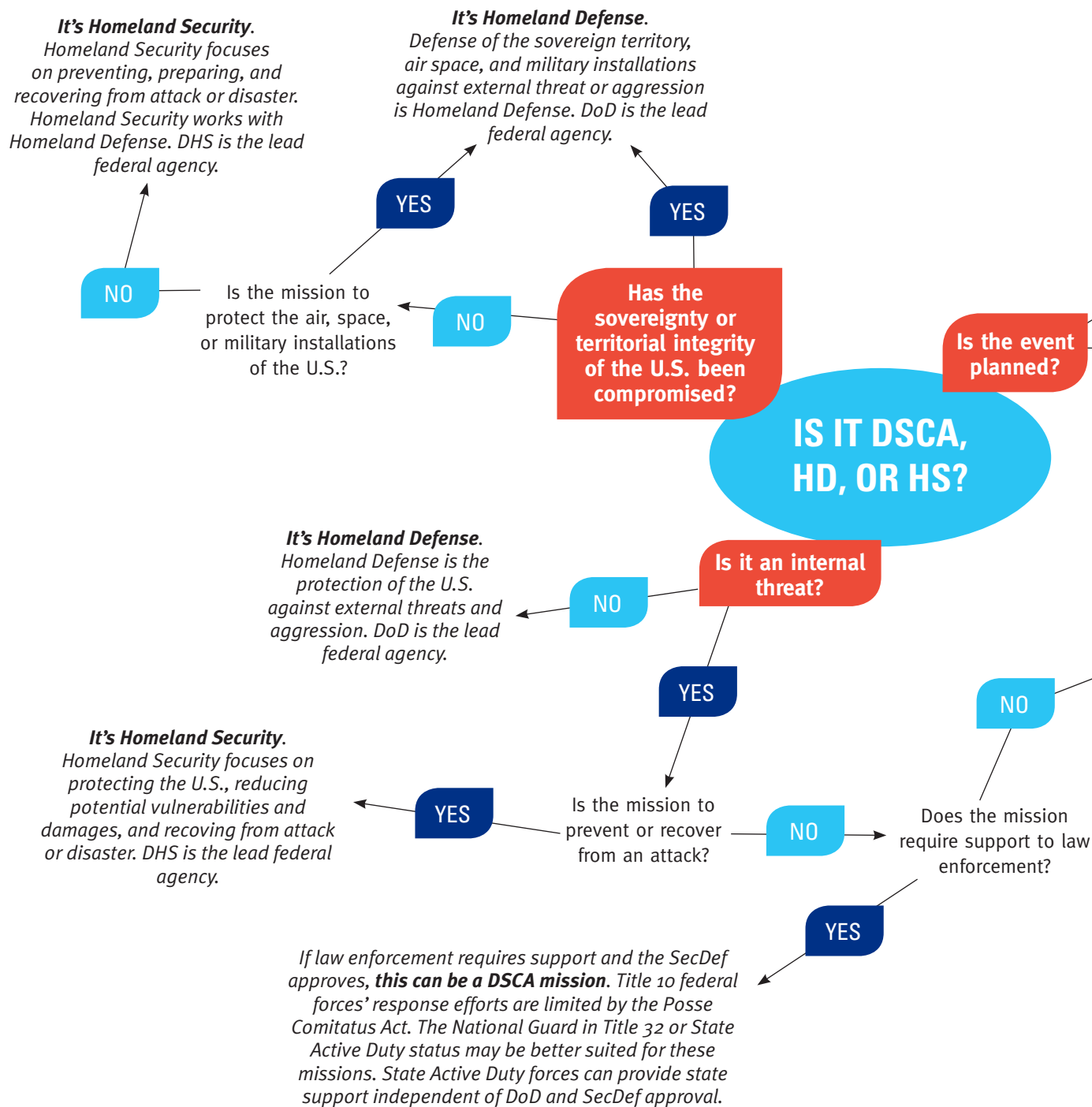
Source: USNORTHCOM/NORAD, Staff Visit, September 9-11, 2013.



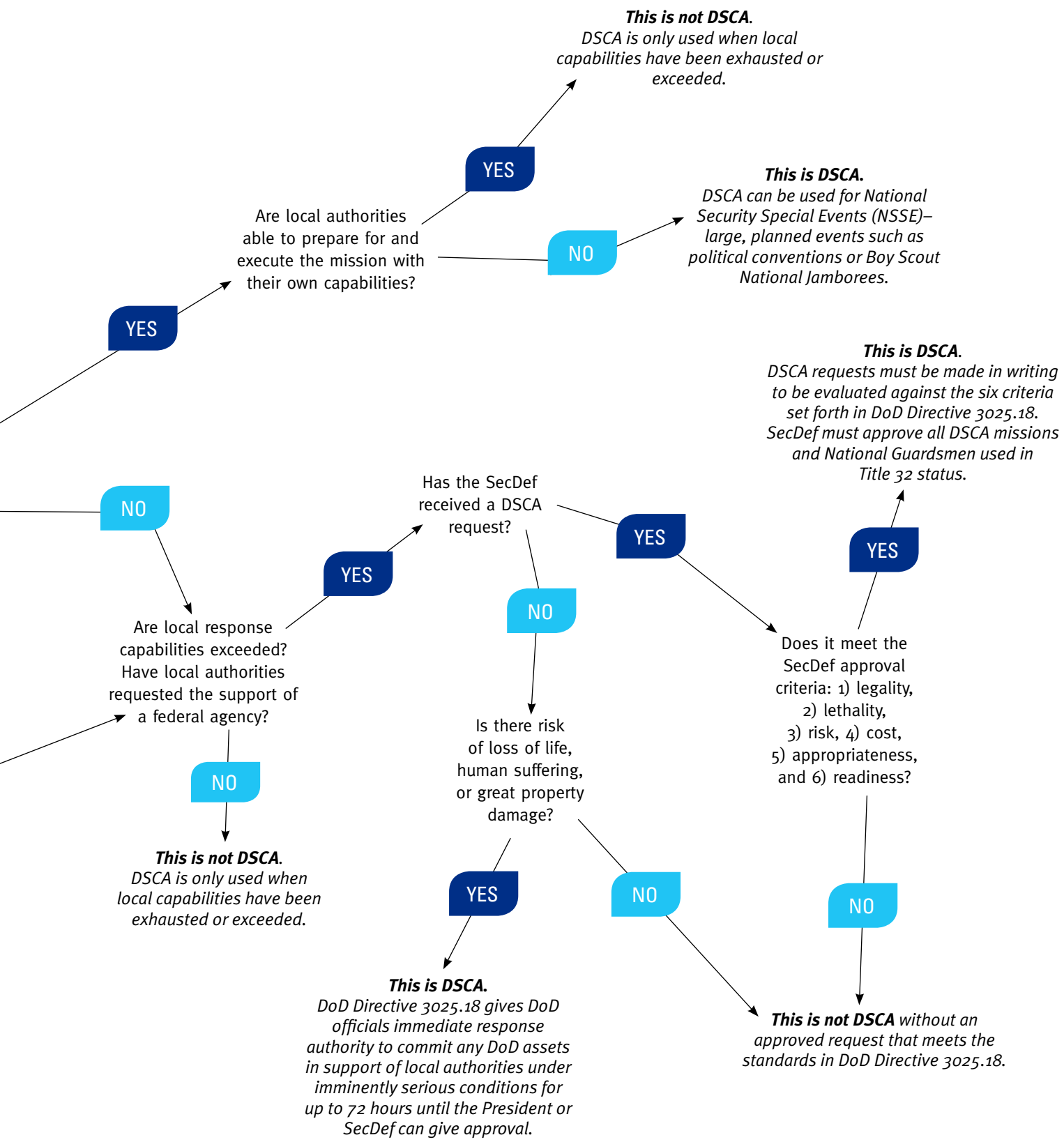
# APPENDIX O DISTINCTIONS AMONG HOMELAND OPERATIONS

FIGURE 14: **Is it Defense Support to Civil Authorities (DSCA), Homeland Defense (HD), or Homeland Security (HS)?**

**THE ANSWER DEPENDS ON THE QUESTION.**







## APPENDIX P

# COMMISSIONER BIOGRAPHIES

### **CHAIR, HONORABLE DENNIS M. MCCARTHY, LIEUTENANT GENERAL, USMC (RET)**

Dennis McCarthy began his Marine Corps service in 1967 as a platoon leader in Vietnam and completed it in 2005 as Commander of Marine Forces Reserve. He led the Marine Forces Reserve for four years during the Corps' largest reserve mobilization in its history. His primary responsibility was setting the conditions that enabled Marines to successfully serve their nation in combat in Iraq, Afghanistan, and around the world.

After completing his service in uniform, he was Executive Director of the Reserve Officers Association of the United States, an organization of 60,000 members with a historic commitment to promote national security. Operating from its iconic headquarters on Capitol Hill, ROA continued its 90-year tradition of leadership and innovation during Chairman McCarthy's tenure.

While serving as Executive Director, Chairman McCarthy was nominated by President Barack Obama and confirmed by the Senate to be Assistant Secretary of Defense for Reserve

Affairs. As Assistant Secretary of Defense, he was responsible for policy development and execution for over one million members of the National Guard and Reserves of all services. His office also supervised activities relating to reserve mobilization, training, and facilities. He worked closely with key budget officials and with Members of Congress and with Congressional Committee staffs.

From 1978 to 1999, Chairman McCarthy was a civil trial lawyer in Columbus, Ohio. He was Board Certified by the National Board of Trial Advocacy, an Adjunct Faculty member at Capital University Law School, a leader in state and national trial lawyer organizations, and a frequent CLE lecturer and contributor. During this period, he was active in the Marine Corps Reserve and was recalled to active duty as a Marine infantry officer on multiple occasions, including command of the Third Marine Division. He returned to active duty full time in 1999 and served until his retirement in 2005, completing more

than 40 years of Active and Reserve military service.

In 2010, he was awarded an Honorary Doctor of Laws degree by Capital University Law School and was named the Distinguished Alumnus for 2011. He currently serves on several advisory boards. Prior to his return to government service in 2009, he was Vice Chairman of the Board of Medifast, Inc. (NYSE: MED) and was a member of the Board of Directors of Rivada Networks, Inc.

He is now Counsel to McCarthy Law Offices (a firm founded by his son, attorney Michael D. McCarthy) and a Principal in Military Experts, LLC, a consulting firm that combines military expertise with government and business leadership to provide analysis, advice, and assessment to business leaders and attorneys. He also serves on the Board of Counselors at the Capital University Law School and is a founding member of the Ross Leadership Institute of Columbus, Ohio.

## VICE CHAIR, HONORABLE ERIN C. CONATON

Erin C. Conaton is currently President of Conaton Strategies, LLC, and a consultant with J.A.Green & Co. She has 15 years of experience in defense policy, programs, and budgeting; military strategy; and military personnel policy and readiness. She recently left government service after serving three years as a senior Senate-confirmed appointee, first as Under Secretary of the Air Force and most recently as Under Secretary of Defense for Personnel and Readiness.

As Under Secretary of Defense for Personnel and Readiness, she served as the senior policy advisor to the Secretary of Defense and Deputy Secretary of Defense on all matters concerning recruitment, career development, military health care, and pay and benefits for 1.4 million Active military personnel, 1.3 million Guard and Reserve personnel, and more than 782,000 DoD civilians. She was also responsible for overseeing the overall state of military readiness and for managing the Department of Defense's relationship with the Department of Veterans Affairs

Ms. Conaton served as Under Secretary of the Air Force from March 2010 until early June 2012. As Under Secretary of the Air Force, Ms. Conaton was responsible for the affairs of the Department of the Air Force including the organizing, training, equipping, and providing for the welfare of its 680,000 members and their families. She also served as the Air Force Chief Management Officer, oversaw the Air Force's annual budget of more than \$119 billion, and served as Acting Secretary of the Air Force in the Secretary's absence.

Prior to becoming Under Secretary of the Air Force, Ms. Conaton served as Staff Director of the U.S. House of Representatives Committee on Armed Services, where she served as primary adviser on defense matters to the Chairman and 61 other Members; directed overall operations, and strategic planning; and led the substantive agenda of the committee, including drafting and overseeing the National Defense Authorization Act. Ms. Conaton also previously served as Minority Staff Director and

Professional Staff Member on the committee.

Ms. Conaton has served as the Research Staff Director for the U.S. Commission on National Security/21st Century, also known as the Hart-Rudman Commission. The commission was charged by the Secretary of Defense to design a national security strategy for a changing global environment through 2025 and to recommend plans for implementing this strategy. She has held several fellowships, including those at the Central Intelligence Agency, where she worked within the Office of Asia-Pacific and Latin American Analysis; and at the National Security Council, with the Directorate of Nonproliferation and Export Control. She has also served as a Term Member of the Council on Foreign Relations.

Ms. Conaton earned a Master of Arts in law and diplomacy from The Fletcher School, Tufts University, Medford, Mass., and a Bachelor of Science in foreign service from Georgetown University, Washington D.C.

## HONORABLE F. WHITTEN PETERS

Whit Peters is a partner at Williams & Connolly LLP in Washington, DC. From 1999 to 2001 he served as the Secretary of the Air Force.

Previously, from 1997 to 1999, he was Under Secretary and Acting Secretary of the Air Force. From 1995 to 1997, Mr. Peters was Principal Deputy General Counsel at the Department of Defense. Before his service at the Department of Defense, he practiced law at Williams & Connolly, which he joined in 1978.

Mr. Peters joined the Navy as a Reserve officer in January 1969 and graduated as a distinguished graduate and company commander the following June. He served at the Atlantic Fleet Intelligence Center in Norfolk, Va., running the systems and programming division of the computer center. He was released by the Navy in February 1972 and immediately hired back as a civilian employee to complete a project. In August 1972 he earned a Frank Knox Traveling Fellowship

from Harvard University to attend the London School of Economics where, the following year, he earned a Master of Arts with distinction in economics. He entered Harvard Law School where for two years he served as president of the Harvard Law Review and graduated magna cum laude with a Doctor of Laws degree in 1976.

He holds a Bachelor of Arts from Harvard University, a Master of Science from the London School of Economics, and a J.D. from Harvard Law School.

## HONORABLE LES BROWNLEE

Les Brownlee served as the Acting Secretary of the Army from May 10, 2003 until Nov. 18, 2004. He became the 27th Under Secretary of the Army Nov. 14, 2001, following his nomination by President George W. Bush and confirmation by the U.S. Senate. Mr. Brownlee served concurrently as both Acting Secretary of the Army and Under Secretary of the Army for 18 months, thereby becoming the longest-serving Acting Secretary of the Army in history.

Mr. Brownlee's statutory responsibilities as Acting Secretary included recruiting, organizing, supplying, equipping, training and mobilizing the Army and managing its \$100 billion annual budget and more than 1.3 million Active, National Guard, Army Reserve and civilian personnel. Mr. Brownlee also served concurrently as Acting Assistant Secretary of the Army for Civil Works from March 2002 to August 2003. Mr. Brownlee served previously on the Republican staff of the Senate Armed

Services Committee beginning in January 1987 under both Sen. Strom Thurmond and Sen. John Warner. From 1987 to 1996, he was the principal professional staff member responsible for Army and Marine Corps programs, Special Operations forces and drug interdiction policy. As deputy staff director, he was deeply involved in policies and programs relating to ballistic missile defense; strategic deterrence and naval strategy; shipbuilding; and weapons programs. In March, 1996, Mr. Brownlee was designated Staff Director of the Senate Committee on Armed Services by then Chairman, Sen. Strom Thurmond. In January, 1999, he was designated Staff Director by then Chairman, Sen. John Warner, serving through a change in control of the Senate in mid-2001.

Mr. Brownlee is a retired Army colonel. He was commissioned in 1962 as a lieutenant of infantry through the ROTC program at the University of Wyoming. He is a distinguished honor graduate of the U.S. Army Ranger

Course, an honor graduate of both the Infantry Officer Advanced Course and the Command and General Staff College, and a graduate of the Army Airborne course as well as the U.S. Army War College. He holds a master's degree in business administration from the University of Alabama. Mr. Brownlee served two combat tours in Vietnam. Before retiring in 1984, he was Military Executive to the Under Secretary of the Army. His military decorations include two Silver Stars, three Bronze Stars and the Purple Heart. He has been inducted into the Ranger Hall of Fame and was named winner of the U.S. Army Infantry's prestigious "Doughboy Award" for 2012. Mr. Brownlee served as a commissioner on the National Commission on the National Guard and Reserve Forces. He is a member of the board of directors of Blue Star Families and is currently the senior vice president for business development for Enersol Technologies, Inc.

## GENERAL RAYMOND E. JOHNS, JR., USAF (RET)

Ray Johns retired from active duty in January 2013. He joined Flight Safety International as the Senior Vice President for Government Business in January 2014. Prior to retirement, he served as Commander, Air Mobility Command, Scott Air Force Base, Ill. From 2006 to 2009 General Johns served as Deputy Chief of Staff for Strategic Plans and Programs, Headquarters U.S. Air Force, Washington, D.C., where he developed, integrated, evaluated and analyzed the U.S. Air Force Future Years Defense Program and the Air Force Long Range Plan. From 2004 to 2006, General Johns served as Director of Programs,

Office of the Deputy Chief of Staff for Strategic Plans and Programs.

General Johns graduated from the U.S. Air Force Academy in 1977. His aviation career includes C-141, C-17, KC-10, N/K/C-135, T-38 instructor pilot, as well as the chief test pilot and test program manager for the VC-25 Air Force One. He was chosen as a White House Fellow in 1991, where he was a Senior Staff Member in the Office of National Service. The general has served at Headquarters U.S. European Command in security assistance and congressional affairs, and at Headquarters U.S. Pacific Command as Deputy Director of Strategic Plans and

Policy. Within Headquarters U.S. Air Force, he served as Deputy Director and, later, Director of Air Force Programs. The general commanded a test squadron, operations group, and airlift wing, and he was the Director of Mobility Forces for operations in Bosnia.

General Johns was a command pilot and experimental test pilot whose aviation career included more than 5,000 flying hours in more than 80 different aircraft. He holds a Bachelor of Science from the U.S. Air Force Academy, and a Master of Science from Central Michigan University.

**LIEUTENANT GENERAL HARRY M. WYATT III, USAF (RET)**

Bud Wyatt retired from active duty on January 30, 2013, finishing his U.S. Air National Guard career as the Director of the Air National Guard. Prior to that assignment, Lt. Gen. Wyatt served as the Adjutant General of Oklahoma, responsible for commanding units of the Air and Army National Guard. As the Director of the Air National Guard, he was responsible for formulating, developing and coordinating all

policies, plans, and programs affecting more than 106,700 Guard members in more than 88 flying wings and 200 geographically separated units throughout the United States, Puerto Rico, Guam, and the Virgin Islands.

Lt. Gen. Wyatt entered the Air Force in 1971 and graduated from undergraduate pilot training at Laredo Air Force Base, Texas, in 1973. He is a command pilot with more than 3,000

hours in the A-7, C-26, F-16, F-100, F-106, T-33, T-37 and T-38 aircraft. His personal decorations include the Air Force Distinguished Service Medal, the Legion of Merit, and the Meritorious Service Medal with oak leaf cluster.

He holds a Bachelor of Arts from Southern Methodist University and a J.D. from the University of Tulsa.

**DR. JANINE A. DAVIDSON**

Janine Davidson is a Senior Fellow at the Council on Foreign Relations. Previously she had been an Assistant Professor in the School of Public Policy at George Mason University, where she taught courses on national security, civil-military relations, and public policy. From 2009 to 2012, she served as the Deputy Assistant Secretary of Defense for Plans, where she oversaw the development of guidance for military campaign and contingency plans. She also led policy efforts for U.S. global defense posture and international agreements related to U.S. forces stationed overseas while co-chairing the U.S.–Australia defense

posture working group. In 2012, she was awarded the Secretary of Defense Medal for Outstanding Public Service.

Dr. Davidson began her career in the U.S. Air Force, where she was an aircraft commander and senior pilot for the C-130 and the C-17 cargo aircraft. She flew combat support and humanitarian air mobility missions in Asia, Europe, and the Middle East, and was an Instructor Pilot at the U.S. Air Force Academy. Previous positions include serving as Director for Stability Operations Capabilities in the Office of the Assistant Secretary of Defense for Special Operations and Low Intensity Conflict (2006 to 2008), associate at

DFI International (2003 to 2004), research and non-resident fellow at the Brookings Institution (2004; 2008), and director at Hicks and Associates (2005 to 2006).

Dr. Davidson holds a Ph.D. and a Master of Arts in international studies from the University of South Carolina, and a Bachelor of Science in architectural engineering from the University of Colorado at Boulder. She is a member of the Council on Foreign Relations, a non-resident Senior Fellow at the Center for New American Security, and author of *Lifting the Fog of Peace: How Americans Learned to Fight Modern War*.



**DR. MARGARET C. HARRELL**

Meg Harrell is the Director of the Army Health Program and a senior social scientist at the RAND Corporation.

During her tenure at the RAND Corporation, Dr. Harrell's research has addressed military manpower and personnel, military families and quality of life, and veterans' issues. She has led or co-led projects addressing the resiliency of military families; the effects of deployment on Active and Reserve Component families; the promotion and management

of military generals and admirals; assignment policies for military women; how best to promote, develop, and assign military officers; and how to ensure the well-being of veterans.

From July 2011 to August 2012 she served concurrently as Senior Fellow and Director of the Military, Veterans, and Society Program at the Center for a New American Security (CNAS).

While at CNAS, she co-authored *Losing the Battle: The Challenge of Military Suicide*; *Well After Service: Veteran Reintegration and American*

*Communities*; and *Employing America's Veterans: Perspectives from Businesses*.

She holds a Bachelor of Arts with Distinction from the University of Virginia, a Master of Science in systems analysis and management from George Washington University, and a Ph.D. in Cultural Anthropology from the University of Virginia, where her dissertation was entitled, "Brass Rank and Gold Rings: Class, Race, Gender, and Kinship with the Army Community."

## APPENDIX Q

# COMMISSION STAFF

### EXECUTIVE DIRECTOR: DR. JAMES A. BLACKWELL, JR.

Confirmed as Executive Director by the Commissioners on May 3, 2013, Dr. Blackwell has previously been called upon by Defense Secretaries Donald Rumsfeld and Robert Gates to serve as Executive Director for investigatory task forces on DoD Detention Operations (2004) and DoD Nuclear Weapons Management (2008). He is detailed to the Commission from his duties as Special Advisor to the Assistant Chief of Staff, Strategic Deterrence and Nuclear Integration, Headquarters U.S. Air Force, Washington, D.C. In this capacity he is responsible for providing expertise and intellectual leadership

to the Air Force on policy, strategy, planning, and budgeting for deterrence as well as engaging in arms control and intelligence analysis. Dr. Blackwell assists and advises the Air Force in establishing and sustaining a culture of critical self-assessment, excellence, precision, and reliability in the nuclear mission.

Dr. Blackwell is a 1974 graduate of the U.S. Military Academy at West Point and has directed a number of ground-breaking studies and analyses of complex problems confronting the armed forces. He also is an internationally recognized author and military analyst. He has served as

an executive in both think tanks and corporate enterprises in defense studies and analysis. In the 1990s he regularly appeared in global broadcast media as an expert in military operations. He was an Assistant Professor at West Point. He had an exemplary term of service as an Army officer in a variety of command and staff positions prior to his medical retirement in 1987. He holds a Ph.D. in international security studies and a Master of Arts in law and diplomacy from The Fletcher School of International Law and Diplomacy at Tufts University, Medford, Mass.

Marcia Moore, Designated Federal Officer  
 Col George Degnon, USAF, Director of Staff  
 Maj Gen Greg Schumacher, USA (Ret.), Director of Analysis  
 Dr. Kathleen Robertson, SES (Ret.), Director of Research  
 Doug Nichols, Chief of Operations  
 Trevor Grange, Chief of Support  
 Eric Minton, Chief of Strategic Communications  
 Bill Nieuwsma, Chief of Governmental Relations  
 James McCleskey, Chief of State and Local Government Relations  
 Barry Willey, Chief of Public Affairs  
 Col Terrence Dunne, USMC, Senior Analyst  
 CAPT Andrew Westerkom, USN, Senior Analyst  
 Patrick Harding, Senior Analyst  
 John Thurman, Senior Analyst  
 Darryl Taylor, Senior Analyst

Dr. Shirley Ross, Senior Analyst  
 Dwayne Baxter, Senior Analyst  
 King Gillespie, Senior Analyst  
 Dr. Deron Hurst, Senior Analyst  
 Jeffrey Cohen, Senior Analyst  
 Eric Jorgensen, Senior Analyst  
 Lt Col Tracy Smith, USAF, Senior Analyst  
 Lt John Swisher, USAF, Analyst  
 Maj David Willard, USAF, Analyst  
 Cathy Haverstock, Senior Researcher  
 Maj Jason Sander, USAF, Senior Researcher  
 Christie Jones, Research Analyst  
 Jaime Hastings, Research Analyst  
 Amy Grace Peele, Research Analyst  
 Chase Ludwig, Research Analyst  
 Rachael Wylie Chestnut, Research Analyst  
 Dustin LeClair, Research Analyst  
 Elizabeth Irwin, Research Analyst  
 Carol Winick, Research Analyst  
 Sean F. Conroy, Military Executive

Webster Bridges, Planning Officer  
 LTC Tim Smith, USA, Planning Officer  
 MSgt Chris Smith, USAF, Security Manager  
 Zachary Sherrod, Operations Assistant  
 Emily Pickett, Operations Assistant  
 Christopher Bisett, Executive Assistant  
 Beverly Parker-Freeman, Executive Assistant  
 Gabrielle Mazurek, Assistant to the DFO  
 SPC(P) Vanessa Morris, USA, Archivist  
 Gunnar Almgren, Facilities Manager  
 Omar Ismail, Webmaster  
 Laurel Moran, Graphic Designer  
 Ken O'Reilly, WHS Representative to NCSAF  
 Al Lopez, EITSD Representative to NCSAF  
 Jamal Turner, EITSD Representative to NCSAF

## APPENDIX R

# SOURCES CONSULTED

- Advisory Panel on the Department of Defense Capabilities for Support of Civil Authorities after Certain Incidents. 2010. *Before disaster strikes: Imperatives for enhancing Defense Support for Civil Authorities*. Washington, D.C.: Government Printing Office.
- Ahmann, LTC Luke, and LTC Liesl Carter. 2012. *Total Force Optimization*. Boston: John F. Kennedy School of Government National Security Program <http://www.ngaus.org/sites/default/files/Total%20Force%20Optimization%20Study-Harvard%20LTC%20Ahmann.pdf> (accessed September 24, 2013).
- Air, Land, Sea Application Center. 2013. *Multi-Service Tactics, Techniques, and Procedures for Defense Support of Civil Authorities and Integrating with National Guard Civil Support*.
- American Forces Press Service. 2012. DOD provides update for Hurricane Sandy response, 2 Nov. <http://www.defense.gov/news/newsarticle.aspx?id=118385>
- Barno, LTG David W., Nora Bensahel, and Travis Sharp. 2011. *Hard Choices: Responsible Defense in an Age of Austerity*.
- Bigelow, James H. and Albert A. Robbert. 2011. *Rand Project Air Force – Balancing Rated Personnel Requirements and Inventories*. Santa Monica: RAND Corporation.
- Bowman, Steve, Lawrence Kapp, and Amy Belasco. 2005. *Hurricane Katrina: DOD Disaster Response*. Washington, D.C.: Congressional Research Service.
- Branstad, Terry, Governor, and Martin O'Malley, Martin, Governor. Letter to Senators Charles T. Hagel and Ashton B. Carter, August 20, 2013.
- Brauner, Marygail, Harry Thie, and Roger Brown. 1992. *Assessing the Structure and Mix of Future Active and Reserve Forces: Effectiveness of Total Force Policy during the Persian Gulf Conflict*. Santa Monica: RAND Corporation.
- Cantwell, Gerald T. 1994. *Citizen Airmen: A History of the Air Force Reserve, 1946-1994*. Washington, D.C.: U.S. Government Printing Office.
- Carwile, William. 2005. Unified Command and the State-Federal Response to Hurricane Katrina in Mississippi. *Homeland Security Affairs* 1, no. 2 : 1-13.
- Conroy, MAJ Sean. 2011. "Accessibility: Improving the Mobilization Framework in Order to Leverage Availability of the Air National Guard." *Air & Space Power Journal* 25, no. 1 : 17-25.
- Commission on the National Guard and Reserves. 2008. *Transforming the National Guard and Reserves into a 21st-Century Operational Force*. Washington, D.C.: Government Printing Office.
- Conway, James T., Gary Roughead, and Thad W. Allen. 2007. *A Cooperative Strategy for 21<sup>st</sup> Century Seapower*. <http://www.navy.mil/maritime/maritimestrategy.pdf> (accessed September 24, 2013).
- Cook, Cynthia, Albert Robbert, and William Williams. 1999. *Principles for Determining the Air Force Active/Reserve Mix*. Santa Monica: RAND Corporation.
- Boyd, Donald C., Betty R. Kennedy, Stephen P. Ove, and Keith L. Barr. 2012. *Turning Point Air Force Reserve in the 21st Century 2001-2011*. Washington, D.C.: Air Force Reserve Command Directorate of Historical Services.
- Doyle, Colin, David Graham, Tim Ni, and Steven Walser. 2013. *The Reserve Component Simulation Model*. Washington, D.C.: Institute for Defense Analyses.
- Doyle, Colin. 2013. *The Military Career Analysis Model*. Washington, D.C.: Institute for Defense Analyses.
- Dyches, MG Tommy, MG Bugs Forsythe, MG Andy Love, MG Dick Platt, and MG Frank Scoggins. 2011. A Unified USAF Air Reserve Component. Washington, D.C.
- Ebbighausen, MAJ John H. 2006. Unity of Command for Homeland Security: Title 32, Title 10, or a Combination. Master's thesis, U.S. Army Command and General Staff College.

- Federal Emergency Management Agency. 2012. Hurricane Sandy Timeline. <http://www.fema.gov/hurricane-sandy-timeline> (accessed September 30, 2012).
- Feickert, Andrew. 2013. *The Unified Command Plan and Combatant Commands: Background and Issues for Congress*. Washington, D.C.: Congressional Research Service.
- Fick, LTC Douglas E. 2004. The Path to Integration: A look at the past, present, and potential future of integrating Reserve and Active flying units. *Air Force Journal of Logistics* 28, no. 2 : 14 - 25.
- Finklea, Kristin M. 2012. *The Interplay of Borders, Turf, Cyberspace, and Jurisdiction: Issues Confronting U.S. Law Enforcement*. Washington, D.C.: Congressional Research Service.
- Graham, David and Stanley Horowitz. 2013. *The SARA Model: Stochastic Active-Reserve Assessment Model*. Washington, D.C.: Institute for Defense Analyses.
- Graham, David. 2013. *Active-Reserve Force Mix Analytic Framework: Baseline*. Washington, D.C.: Institute for Defense Analyses.
- Grissom, Adam, Jennifer Kavanagh, Leila Mahnad, Patrick Mills, and Stephen Woman. 2013. *A Cost Analysis of the U.S. Air Force Overseas Posture - Informing Strategic Choices*. Santa Monica: RAND Corporation.
- Gross, Charles J. 1985. *Prelude to the Total Force: The Air National Guard, 1943-1969*. Washington, D.C.: Office of Air Force History.
- \_\_\_\_\_. 1985. The Birth of the Air National Guard: A Case Study in Military Institutional Politics. *Military Affairs* (April) : 69-74.
- \_\_\_\_\_. 2000. *Turning Point: The Air National Guard and the Korean War*. Arlington, V.A.: National Guard Bureau.
- Gunzinger, Mark. 2013. *Shaping America's Future Military: Toward a New Force Planning Construct*. Washington D.C.: Center for Strategic and Budgetary Assessments.
- Hagel, Chuck, Secretary of Defense. "Contingency Plan for \$52 Billion Cut in FY 2014 Defense Budget." Letter to Senators Carl Levin and James Inhofe, 10 July 2013.
- Hagel, Chuck, Secretary of Defense. 2013. Statement delivered at the CSIS Global Security Forum, Washington, D.C., 5 November.
- Harrison, Todd, and Mark Gunzinger. 2012. *Strategic Choices Navigating Austerity*. Washington D.C.: Center for Strategic and Budgetary Assessments.
- Hostage III, Gilmery M. "A Combat Air Force Perspective." Keynote speech, Deloitte Center for Cyber Innovation, Washington, D.C., 11 April 2013.
- Jacoby, Charles H. GEN and GEN Frank Grass. OSD Executive Summary: DoD Support of Hurricane Sandy Response – October 28, 2012. <https://www.jllis.mil/apps/index.cfm?do=binders:binder.summary&binderid=3119>
- Jinnette, COL James. 2013. *SASC PSM USAF Fighter Pilot Manning Update*. Powerpoint presentation, 24 May.
- Johnson, COL Bruce K., LTC Scott Kniep, and Sean F. Conroy. 2013. The Symbiotic Relationship between the Air Force's Active and Reserve Components Ensuring the Health of the Total Force. *Air and Space Power Journal* 27, no. 1 (Winter) : 107 - 128.
- Joint Lessons Learned Information System. 2012. "Hurricane Sandy Response Hotwash AAR, 30 November 2012". <https://www.jllis.mil/apps/?do=cops.view&copid=881> (accessed October 7, 2013).
- \_\_\_\_\_. 2013. "Hurricane Sandy AAR and Initiatives to Improve Defense Support of Civil Authorities (DSCA): Brief to DoD-DHS SSG." 1 February. <https://www.jllis.mil/apps/index.cfm?do=binders:binder.summary&binderid=3119> (accessed October 7, 2013).
- \_\_\_\_\_. 2013. *The USAF Total Force Response to Superstorm Sandy*. Washington, D.C. <https://www.jllis.mil/apps/?do=cops.view&copid=881> (accessed September 30, 2013).
- Jones, Priscilla D. 2011. *The First 109 Minutes: 9/11 and the U.S. Air Force*. Washington, D.C.: Air Force History and Museums Program.
- Kapp, Lawrence, and Barbara Salazar Torreon. 2013. *Reserve Component Personnel Issues: Questions and Answers*. Washington, D.C.: Congressional Research Service.
- Knight, William. 2008. *Homeland Security: Roles and Missions for United States Northern Command*. Washington, D.C.: Congressional Research Service.
- Langowski, COL Thomas J. 2008. *Defense Support to Civil Authorities*. Thesis, School of Advanced Military Studies.



- Leatherman, Matthew, Barry Blechman, and Russell Rumbaugh. 2013. *Stimson Center Brief Managing the Military More Efficiently*. Washington D.C.: Stimson Center.
- Lewis, Leslie, Robert C. Roll, and John D. Mayer. 1992. *Assessing the Structure and Mix of Future Active and Reserve Forces: Assessment of Policies and Practices for Implementing the Total Force Policy*. Santa Monica: RAND.
- Lowenberg, MG (Ret.) Timothy J. 2005. The role of the National Guard in National Defense and Homeland Security. *National Guard* 59, no. 9: 1-7.
- Marshall, George C. 1994. *General Principles of National Military Policy to Govern Preparation of Postwar Plans*, War Department Circular 347, printed in United States President, Advisory Commission on Universal Training, A Program for National Security. Washington, DC: US Government Printing Office.
- Mason, R Chuck. 2013. *Military Justice: Courts-Martial, an Overview*. Washington, DC: Congressional Research Service
- Memorandum from Deputy Secretary of Defense Ashton B. Carter to the Department of Defense. *Handling Budgetary Uncertainty in Fiscal Year 2013* (10 January 2013). <http://cpol.army.mil/library/general/20130110-SecDef.pdf>
- Memorandum from Director of Cost Assessment and Program Evaluation Christine H. Fox to the Secretary of Defense. *Comments on the Final Reserve Forces Policy Board Report on Costs of Military Personnel*. (15 March 2013).
- Nagl, John, and Travis Sharp. 2010. *An Indispensable Force: Investing in America's National Guard and Reserves*. Washington, DC: Center for a new American Security.
- National Academy of Sciences. Air Force Studies Board. 2011. *Examination of the U.S. Air Force's Aircraft Sustainment Needs in the Future and Its Strategy to Meet Those Needs*. Washington, DC: National Academies Press.
- National Commission on the Structure of the Air Force. 2013. *Statement by Major General Arnold L. Punaro, USMCR (Ret.)*, 26 June.
- National Defense Research Institute. 1993. *Assessing the Structure and Mix of Future Active and Reserve Forces: Final Report to the Secretary of Defense*. Washington, D.C.: RAND Corporation.
- National Governors Association. "Insurrection Act." Letter to Senators Patrick Leahy and Christopher Bond, February, 5 2007. [http://www.nga.org/cms/home/federal-relations/nga-letters/archived-letters--2007/col2-content/main-content-list/title\\_february-5-200.html](http://www.nga.org/cms/home/federal-relations/nga-letters/archived-letters--2007/col2-content/main-content-list/title_february-5-200.html).
- National Guard Bureau. 2012. *Capabilities Based Assessment Final Report for Fixed/Rotary Wing Support to Homeland Defense/Defense Support to Civil Authorities (HD/DSCA) and State-Level Missions*. Washington, D.C.: MacAulay Brown, Inc.
- O'Malley, Martin, Governor; Brian Sandoval, Governor; and Terry Branstad, Governor. Letter to Senators Carl Levin, James Inhofe, Buck McKeon, and Adam Smith, 5 June 2013.
- Office of the Assistant Secretary of Defense for Readiness and Force Management, Total Force Planning and Requirements Directorate. 2013. *Defense manpower Requirements Report*. Washington, DC.
- Office of the Vice Chairman of the Joint Chiefs of Staff. 2011. *Comprehensive Review of the Future Role of the Reserve Component*. Washington, DC.
- Office of the Secretary of Defense. 2013. *Unit Cost and Readiness for the Active and Reserve Components of the Armed Forces: Report to the Congress*. Washington, DC.
- Office of the Under Secretary of Defense, Comptroller. 2013. *National Defense Budget Estimates for FY 2014*. Washington, DC.
- Office of the Vice Chairman of the Joint Chiefs of Staff and Office of Assistant Secretary of Defense for Reserve Affairs. 2011. *Comprehensive Review of the Future Role of the Reserve Component: Volume I—Executive Summary and Main Report*. Washington, DC.
- Office of the Assistant Secretary of Defense, Homeland Defense and America's Security Affairs. 2008. *Department of Defense support to domestic incidents*. Washington, DC.



- Palmer, Adele R., James H. Bigelow, Joseph G. Bolten, Deena Dizengoff, Jennifer H. Kawata, H. Garrison Massey, Robert L. Petruschell, and Michael G. Shanley. 1992. *Assessing the Structure and Mix of Future Active and Reserve Forces: Cost Estimation Methodology*. Santa Monica: RAND Corporation.
- Phan, LTC M. H. "AFR Tempo, Mobilization and Assured Access." Talking paper presented Oct 6, 2011.
- Powers, LTC P. J. "Access to Forces and Impact on Dwell." Talking paper presented Oct 6, 2011.
- Punaro, Arnold L., William L. Ball, Les Brownlee, Rhett B. Dawson, Larry K. Eckles, Patricia L. Lewis, Dan McKinnon, Wade Rowley, James E. Sherrard III, E. Gordon Stump, and J. Stanton Thompson. 2007. *Commission on the National Guard and Reserves: Strengthening America's Defenses in the New Security Environment*. Washington, DC: Government Printing Office.
- Project Air Force. 1999. *RAND Study - F16 Health Part 2*. Santa Monica: RAND Corporation.
- Reserve Forces Policy Board. 2013. *Eliminating Major Gaps in DoD Data on the Fully-Burdened and Life-Cycle Cost of Military Personnel: Cost Elements Should be Mandated by Policy*. Washington, DC.
- Robbert, Albert A. 2013. *Costs of Flying Units in Air Force Active and Reserve Components*. Santa Monica: RAND Corporation.
- Robinson, COL Brian. "AM GOSG 2013 Scene Setter." Lecture, U.S. Air Force Headquarters. July 9, 2013.
- Rostker, Bernard. 2013. *Right Sizing the Force: Lessons for the Current Drawdown of American Military Personnel*. Washington, DC: Center for a New American Security.
- Roughead, ADM (Ret.) Gary, and Kori Schake. 2013. *National Defense in the Time of Change*. Washington, D.C.: The Hamilton Project.
- Shlapak, David A. 2006. *Shaping the Future Air Force*. Santa Monica: RAND Corporation.
- Smith, David W. 2013. "The Plan, Type, Source, Report Cycle: A Unifying Concept for National Guard Preparedness." *Homeland Security Affairs* 9, article 11 (July). <http://www.hsaj.org/?article=9.1.11>
- Stimson Center. 2012. *A new US defense strategy for a new era: Military superiority, agility, and efficiency*. [http://www.stimson.org/images/uploads/researchpdfs/A\\_New\\_US\\_Defense\\_Strategy\\_for\\_a\\_New\\_Era.pdf](http://www.stimson.org/images/uploads/researchpdfs/A_New_US_Defense_Strategy_for_a_New_Era.pdf) (accessed September 27, 2013).
- Taylor, Willaim W., James H. Bigelow, and John A. Ausink. 2009. *Fighter Drawdown Dynamics: Effects on Aircrew Inventories*. Washington, D.C.: RAND Corporation. [http://www.rand.org/content/dam/rand/pubs/monographs/2009/RAND\\_MG855.pdf](http://www.rand.org/content/dam/rand/pubs/monographs/2009/RAND_MG855.pdf)
- Thie, Harry J., William W. Taylor, Claire Mitchell Levy, Sheila Nataraj Kirby, and Clifford Graf II. 1995. *Total Force Pilot Requirements and Management: An Executive Summary*. Washington, D.C.: RAND Corporation. [http://www.rand.org/content/dam/rand/pubs/monograph\\_reports/2007/MR646.pdf](http://www.rand.org/content/dam/rand/pubs/monograph_reports/2007/MR646.pdf)
- Thie, Harry J., Margaret C. Harrell, Roger A. Brown, Clifford M. Graf II, Mark Berends, Claire M. Levy, and Jerry M. Sollinger. 2001. *A Future Officer Career Management System: An Objectives-Based Design*. Santa Monica: RAND Corporation.
- U.S. Air Force Inspection Agency. 2010. *Role of the Air Component Coordination Element*. <http://www.afia.af.mil/news/story.asp?id=123210289> (accessed August 20, 2013).
- U.S. Air National Guard. Strategic Planning System Steering Committee. 2013. *Report of the ANG 2025 Working Group*.
- U.S. Congress. House. Select Bipartisan Committee to Investigate the Preparation for and Response to Hurricane Katrina. 2006. *A Failure of Initiative*. Washington, DC: Government Printing Office.
- \_\_\_\_\_. House. Committee on Armed Services. 2012. *Department of the Air Force aircraft force structure reductions proposed in the 2013 President's budget request*. 112<sup>th</sup> Cong., 2<sup>nd</sup> sess., 12 July. (statement of Major General Timothy Lowenberg, Adjutant General, Washington National Guard).
- \_\_\_\_\_. House. Appropriations Committee, Subcommittee on Defense. 2011. *The Fiscal Year 2013 Guard and Reserve budget*. 112<sup>th</sup> Cong., 1<sup>st</sup> sess., 28 March. (statement of LTG Harry Wyatt, Director, Air National Guard).

- \_\_\_\_\_. Senate. Committee on Armed Services. 2013. *Statement of General Keith B. Alexander Commander United States Cyber Command Before the Senate Committee on Armed Services*. 113<sup>th</sup> Congr., 1<sup>st</sup> Sess., 12 March.
- U.S. Department of Defense. 2010. *Department of Defense Instruction: Defense Support of Civil Authorities*. DODI 3025.18. Washington, D.C. <http://www.dtic.mil/whs/directives/corres/pdf/302518p.pdf>
- \_\_\_\_\_. 2011. *Strategy for Operating in Cyberspace*. Washington, D.C. <http://www.defense.gov/news/d20110714cyber.pdf>
- \_\_\_\_\_. 2012. *Sustaining U.S. Global Leadership: Priorities for 21st Century Defense*. Washington D.C. [http://www.defense.gov/news/defense\\_strategic\\_guidance.pdf](http://www.defense.gov/news/defense_strategic_guidance.pdf)
- \_\_\_\_\_. 2013. "Defense Budget Priorities Choices." Washington D.C. <http://www.defense.gov/pubs/DefenseBudgetPrioritiesChoicesFiscalYear2014.pdf>
- \_\_\_\_\_. 2013. "Joint Publication 3-27 Homeland Defense." Washington, D.C. [http://www.dtic.mil/doctrine/new\\_pubs/jp3\\_27.pdf](http://www.dtic.mil/doctrine/new_pubs/jp3_27.pdf)
- \_\_\_\_\_. 2013. *Department of Defense Instruction: The Use of the National Guard for Defense Support of Civil Authorities*. DODI 3025.22. Washington, D.C. <http://www.dtic.mil/whs/directives/corres/pdf/302522p.pdf>
- \_\_\_\_\_. 2013. *Strategy for Homeland Defense and Defense Support of Civil Authorities*. Washington, D.C. <http://www.defense.gov/news/homelanddefensestrategy.pdf>
- \_\_\_\_\_. 2013. *National Guard and Reserve Equipment Report for Fiscal Year 2014*. Washington, D.C. <http://ra.defense.gov/documents/publications/NGRER%20FY2014.pdf>
- U.S. Department of Defense. Army Air Forces. Air Defense Command. 1946. *Comparison of Approved War Department Policies Relating to the Postwar National Guard and Organized Reserve Corps*. Washington, D.C.
- U.S. Department of Defense News. 2012. Panetta appoints 'dual' commanders for hurricane relief, 28 Oct. <http://www.defense.gov/News/NewsArticle.aspx?ID=118366> (accessed October 7, 2013).
- U.S. Department of the Air Force. 2010. *Air Force Instruction 10-503: Strategic Basing*. Washington, D.C. <http://www.acq.osd.mil/dpap/ccap/cc/jcchb/Files/FormsPubsRegs/Pubs/afi10-503.pdf>
- \_\_\_\_\_. 2011. *Air Force ISR Agency Instruction 10-501: Air Force Intelligence, Surveillance and Reconnaissance Agency Strategic Basing Process*. Washington, D.C. <http://static.e-publishing.af.mil/production/1/afisra/publication/afisrai10-501/afisrai10-501.pdf>
- \_\_\_\_\_. 2012. *United States Air Force Posture Statement*. Washington, D.C. <http://www.posturestatement.af.mil/shared/media/document/AFD-130619-104.pdf>
- \_\_\_\_\_. 2012. *Air Force Instruction 21-102—Depot Maintenance Management*. Washington, D.C. <http://www.af.mil/shared/media/epubs/AFI21-102.pdf>
- \_\_\_\_\_. 2013. *Air Force Reserve Snapshot: A Summary of Facts and Figures about America's Air Force Reserve*. Washington, D.C. <http://www.afrc.af.mil/shared/media/document/AFD-110413-008.pdf>
- \_\_\_\_\_. 2013. *Homeland Operations: Air Force Doctrine Document 3-27*. Washington, D.C. <https://www.fas.org/irp/doddir/usaf/afdd3-27.pdf>
- \_\_\_\_\_. 2013. *USAF Force Structure Changes: Sustaining Readiness and Modernizing the Total Force*. Washington, D.C. <http://www.defenseinnovationmarketplace.mil/resources/AF%20White%20Paper.pdf>
- \_\_\_\_\_. 2013. *Global Vigilance, Global Reach, Global Power for America*. Washington, D.C. [http://www.af.mil/Portals/1/images/airpower/GV\\_GR\\_GP\\_300DPI.pdf](http://www.af.mil/Portals/1/images/airpower/GV_GR_GP_300DPI.pdf)
- U.S. Department of Homeland Security. 2010. *Quadrennial Homeland Security Review Report: A Strategic Framework for a Secure Homeland*. Washington, D.C. [http://www.dhs.gov/xlibrary/assets/qhsr\\_report.pdf](http://www.dhs.gov/xlibrary/assets/qhsr_report.pdf)
- U.S. Government Accountability Office. 2006. *Hurricane Katrina: Better Plans and Exercises Needed to Guide the Military's Response to Catastrophic Natural Disasters*. GAO-06-643. Washington, D.C.: Government Printing Office.
- \_\_\_\_\_. 2007. *DOD Needs to Establish a Strategy and Improve Transparency over Reserve and National Guard Compensation to Manage Significant Growth in Cost*. GAO-07-828. Washington, D.C.: Government Printing Office
- \_\_\_\_\_. 2008. *Action to Implement the Post-Katrina Act*. GAO-09-59R. Washington, D.C.: Government Printing Office.

- \_\_\_\_\_. 2009. *Reserve Forces: Army Needs to Finalize and Implementation Plan and Funding Strategy for Sustaining an Operational Reserve Force*. GAO-09-898. Washington, D.C.: Government Printing Office
- \_\_\_\_\_. 2009. *Reserve Forces: Army Needs to Reevaluate Its Approach to Training and Mobilizing Reserve Component Forces*. GAO-09-720. Washington, D.C.: Government Printing Office.
- \_\_\_\_\_. 2010. *Homeland Defense: DOD Can Enhance Efforts to Identify Capabilities to Support Civil Authorities during Disasters*. GAO-10-386. Washington, D.C.: Government Printing Office.
- \_\_\_\_\_. 2011. *Defense Management: Perspectives on the Involvement of the Combatant Commands in the Development of Joint Requirements*. GAO-11-527R. Washington, D.C.: Government Printing Office.
- \_\_\_\_\_. 2012. *Homeland Defense: DOD Needs to Address Gaps in Homeland Defense and Civil Support Guidance*. GAO-13-128. Washington, D.C.: Government Printing Office.
- \_\_\_\_\_. 2013. *DOD Needs to Periodically Review and Improve Visibility Of Combatant Commands' Resources*. GAO-13-293. Washington, D.C.: Government Printing Office.
- \_\_\_\_\_. 2013. *Homeland Defense: Action Needed to Improve Cost Reporting for DOD's Aerospace Control Alert Mission*. GAO-13-785. Washington, D.C.: Government Printing Office.
- \_\_\_\_\_. 2013. *Civil Support: Actions are needed to improve DOD's planning for a complex catastrophe*. GAO-13-763. Washington, D.C.: Government Printing Office.
- \_\_\_\_\_. 2013. *Human Capital: Additional Steps Needed to Help Determine the Right Size and Composition of DOD's Total Workforce*. GAO-13-470. Washington, D.C.: Government Printing Office.
- \_\_\_\_\_. 2013. *Human Capital: Opportunities Exist to Further Improve DOD's Methodology for Estimating the Costs of its Workforces*. GAO-13-792. Washington, D.C.: Government Printing Office.
- \_\_\_\_\_. 2013. *Prepositioned Stocks: Inconsistencies in DOD's Annual Report Underscore the Need for Overarching Strategic Guidance and Joint Oversight*. GAO-13-790. Washington, D.C.: Government Printing Office.
- \_\_\_\_\_. 2013. *Space: Defense and Civil Agencies Request Significant Funding For Launch-Related Activities*. GAO-13-802R. Washington, D.C.: Government Printing Office.
- \_\_\_\_\_. 2013. *Defense Management: Actions Needed to Ensure National Guard and Reserve Headquarters are Sized to be Efficient*. GAO-14-71. Washington, D.C.: Government Printing Office.
- U.S. Library of Congress. 2007. *Historical Attempts to Reorganize the Reserve Components*. Washington, D.C. [http://www.loc.gov/rr/frd/pdf-files/CNGR\\_Reorganization-Reserve-Components.pdf](http://www.loc.gov/rr/frd/pdf-files/CNGR_Reorganization-Reserve-Components.pdf)
- Weber, Laura, Agnes Gereben Schaefer, Karen Chan Osilla, Elizabeth Wilke, Anny Wong, Joshua Breslau, and Karin E. Kitchens. 2013. *Support for the 21st Century Reserve Force: Insights on Facilitating Successful Reintegration for Citizen Warriors and Their Families*. Santa Monica: RAND Corporation.
- White House. 2006. *The Federal Response to Hurricane Katrina: Lessons Learned*. <http://www.disastersrus.org/katrina/> (accessed October 7, 2013).
- \_\_\_\_\_. 2010. *National Security Strategy*. Washington, D.C. [http://www.whitehouse.gov/sites/default/files/rss\\_viewer/national\\_security\\_strategy.pdf](http://www.whitehouse.gov/sites/default/files/rss_viewer/national_security_strategy.pdf) (accessed September 30, 2013).
- \_\_\_\_\_. 2011. *Strategy to Combat Transnational Organized Crime: Addressing Converging Threats to National Security*. Washington, D.C. [http://www.whitehouse.gov/sites/default/files/Strategy\\_to\\_Combat\\_Transnational\\_Organized\\_Crime\\_July\\_2011.pdf](http://www.whitehouse.gov/sites/default/files/Strategy_to_Combat_Transnational_Organized_Crime_July_2011.pdf) (accessed September 30, 2013).
- \_\_\_\_\_. 2011. *Presidential Policy Directive/PPD-8*. Washington, D.C. <http://www.dhs.gov/xlibrary/assets/presidential-policy-directive-8-national-preparedness.pdf> (accessed October 7, 2013).







# National Commission on the Structure of the Air Force

---

Report to the President and Congress of the United States

JANUARY 30, 2014